

WPMZ series

Modbus communication

instruction manual

Supported module type
WPMZ-1/3

Ver.1.00

Instruction manual number IM-0887-01

Table of contents

INTRODUCTION	2
1. OVERVIEW	3
1-1. WHAT CAN BE DONE WITH THIS FUNCTION?	3
2. MODULE COMMUNICATION SPECIFICATION	4
2-1. SUPPORTED MODULES	4
2-2. MODULE COMMUNICATION SPECIFICATION	4
2-3. MODULE WIRING (RS-485 COMMUNICATION OPTION)	5
2-3-1. <i>Wiring method</i>	5
2-3-2. <i>Connection terminal</i>	5
2-3-3. <i>Configuration diagram example</i>	6
2-4. MODULE WIRING (RS-232C COMMUNICATION OPTION)	8
2-4-1. <i>Connection terminal</i>	8
2-4-2. <i>Configuration diagram example</i>	8
3. MODBUS COMMUNICATION SPECIFICATION	9
3-1. COMMUNICATION PROCEDURE	9
3-2. TRANSMISSION SWITCHING TIME.....	9
3-3. MESSAGE.....	10
3-3-1. <i>Composition of messages</i>	10
3-3-2. <i>Message Contents</i>	10
3-3-3. <i>Types of data</i>	10
3-3-4. <i>Slave ID</i>	10
3-3-5. <i>Function code</i>	11
3-3-6. <i>Format Details</i>	11
3-4. ERROR DETECTION	17
3-4-1. <i>CRC-16</i>	17
3-4-2. <i>Calculation of CRC-16</i>	17
3-5. ERROR MESSAGE.....	20
4. COMMUNICATION EXAMPLE	21
4-1. WPMZ-1/3	21
4-1-1. <i>Acquire measurement data</i>	21
4-1-2. <i>Change control parameters</i>	22
4-1-3. <i>Change setting parameters</i>	23
5. ADDRESS MAP	26
5-1. WPMZ-1/3	26
5-1-1. <i>Setting and control parameters</i>	26
5-1-2. <i>Measurement data</i>	52
6. TROUBLESHOOTING	57
6-1. ABOUT COMMUNICATION	57
6-1-1. <i>Communication abnormal</i>	57
6-1-2. <i>The acquired data is abnormal</i>	57

Modbus is a registered trademark of Modicon Inc. (AEG Schneider Automation International S.A.S).

Introduction

This instruction manual explains notes, information and setting method when using Modbus communication of WPMZ series.

Please observe the following in order to use the product correctly and safely.

- Please read this instruction manual thoroughly before use and use it properly.
- Before constructing the system, carefully read the Modbus compatible products and other equipment's instruction manuals to be used, and use them correctly.
- After reading, carefully keep it and read it when you need it.

Usage restrictions

- **Please note that the contents of this manual may be changed without notice.**

We will not be held responsible in any case for special damages, indirect damages, losses caused by this manual.

In this operation manual, hexadecimal data is indicated by appending "H" after the numerical value. Nothing is appended to decimal data.

Example) Hexadecimal number: 123H, decimal number: 123

1. Overview

We will explain the specification of Modbus communication of WPMZ series.

This manual is intended for engineers who connect from Modbus Master to Modbus compatible products and create processing to collect settings and data.

As a Modbus master, it is assumed to be a PC or Programmable Logic Controller (PLC). Please prepare equipment to be used for Modbus master in advance.

First, refer to "2. Module communication specification" and set the module (WPMZ - 1/3) connected to the Modbus master so that it conforms to the communication specifications.

Then refer to "5. Address Map" of the corresponding module according to "3. Modbus communication specification" and set and read the necessary items.

1-1. What can be done with this function?

For products with RS-232C option output, you can select Modbus protocol and original protocol. The following table shows the contents that can be communicated by each protocol.

Note that only Modbus protocol can be selected for products with RS-485 option output, and original protocols can not be selected.

Function	Modbus protocol (Mentioned in this document)	Original protocol
Getting setting value	○	×
Setting change /control	○	×
Getting measured value and comparison judgment value	○	○
Measurement, hold instruction, instruction cancellation	×	○
Original output of measured value	×	○

2. Module communication specification

2-1. Supported Modules

The corresponding modules assumed in this manual are as follows.

WPMZ-1
 WPMZ-3

2-2. Module communication specification

The communication specifications when connecting to each module are as shown in the table below.

Table 2.1 Communication specification of module (RS-485 communication option)

item	WPMZ-1/3
Standard	RS-485 compliant
Protocol	Modbus(RTU)
Synchronous mode	Asynchronous type
Communication method	2-wire half-duplex
Error detection method	CRC-16
communication speed	9600bps, 19200bps, 38400bps
Data length	8 (fixed)
Start bit	1(fixed)
Parity bit	Selection from eve, odd, none
Stop bit	1, 2 (Stop bit 2 can be set only when there is no parity)
Signal name used	Non-inverted (+), inverted (-)
Terminating resistance	Approximately 120 Ω (Connected by short-circuiting TERM terminals)
Number of connected units	31 (number of slave devices)
Configurable address	1~31 (0 can not be used)
Transmission distance (total)	1.2km *For CE mark conformance, less than 30 m

Table 2.2 Module communication specification (RS-232C communication option)

item	WPMZ-1/3
Standard	RS-232C compliant
Protocol	Modbus(RTU)
Synchronous mode	Asynchronous type
Communication method	Full duplex
Error detection method	CRC-16
communication speed	9600bps, 19200bps, 38400bps
Data length	8 (fixed)
Start bit	1(fixed)
Parity bit	Selection from eve, odd, none
Stop bit	1, 2 (Stop bit 2 can be set only when there is no parity)
Signal name used	TXD, RXD, SG
Terminating resistance	-
Number of connected units	1 (number of slave devices)
Configurable address	1 only (0 can not be used)
Transmission distance (total)	15m

2-3. Module wiring (RS-485 communication option)

2-3-1. Wiring method

The Modbus communication wiring is wired in a daisy chain (daisy chaining).

If there are multiple branches from the star wiring or module, it may not be able to communicate properly.

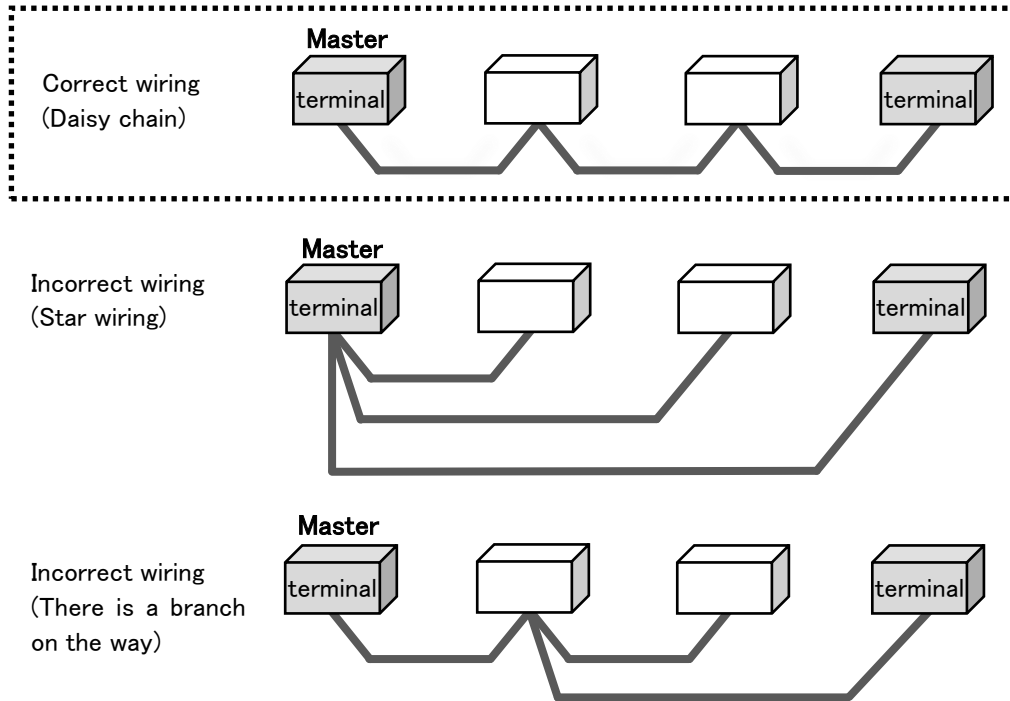

Figure 2.1 Wiring of Modbus communication

2-3-2. Connection terminal

This section describes the Modbus (RS485) connection terminals of the module.

1. WPMZ-1/3

Modbus (RS485) connection terminal of WPMZ-1/3 is as shown below.

28 and 31, 29 and 32 are conducting inside the equipment respectively.

(Since the connector inside does not have continuity, communication lines and remove the connector will be disconnected.)

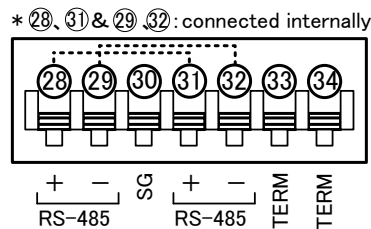

Suitable wire: AWG24 to 16

Figure 2.2 Modbus communication wiring

Table 2.3 Connector contents

Terminal number	Symbol	Contents
28,31	RS485	+
29,32		-
30		SG
33,34		TERM (*)
		Terminal resistance (120Ω) terminals * Short 33 and 34 to be enable the resistance.

2-3-3. Configuration diagram example

The configuration example of WPMZ - 1/3 is shown below.

1. About communication cable

Please use a shielded cable that meets the following specifications.

Table 2.4 Communication cable specification

Product name	Size	Total cable extension
WPMZ-1/3	AWG24~16	1.2km or less

2. About connection of terminating resistor

Up to 31 slaves (modules) can be connected.

At that time, please set the terminating resistor for the module which becomes the terminal equipment of the line.

In the case of WPMZ-1/3, connect the TERM terminals together.

If this product is not a terminal equipment of the line, please do not set the termination resistor.

When connecting via Modbus using the USB - RS 485 converter, even if the master is a personal computer, set the terminating resistor in the USB - RS 485 converter. (See the figure below)

Note: Do not configure multiple masters to connect to the same slave (module).
 Communication may not be performed correctly and data may not be taken.

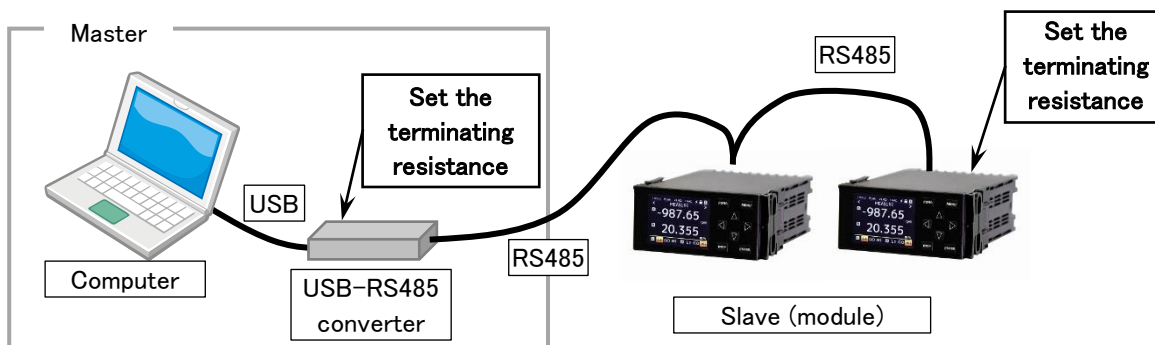

Figure 2.3 Terminating resistance when USB-RS 485 converter is used

3. Connection diagram

The Modbus connection of WPMZ - 1/3 is shown below.

Please set the terminating resistance to the master and slave at the final end (WPMZ in the figure below).

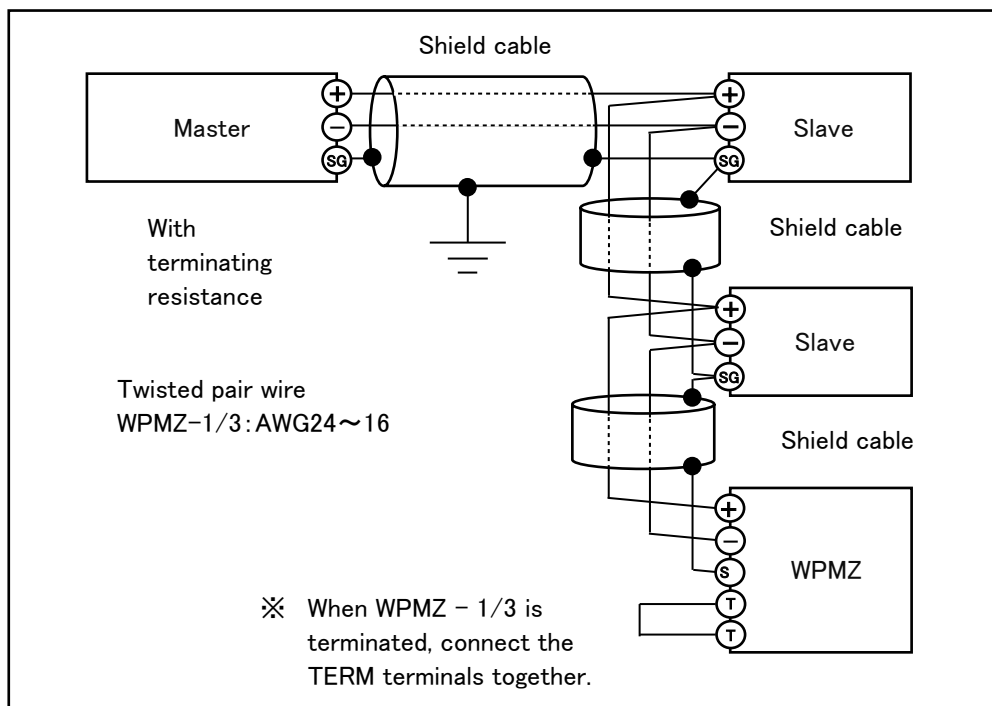

Figure 2.4 Modbus connection of WPMZ-1/3

Table 2.5 Modbus connection terminal (WPMZ - 1/3)

Terminal number	symbol		Contents
28,31	RS485	+	Communication plus terminal
29,32		-	Communication minus terminal
30		SG	Communication SG terminal
33,34		TERM (*)	Terminal resistor terminal (120 Ω)

※ When connecting the TERM terminals to each other, the terminating resistance becomes effective.

2-4. Module wiring (RS-232C communication option)

2-4-1. Connection terminal

The figure below shows the RS - 232C connection terminal of WPMZ - 1/3.

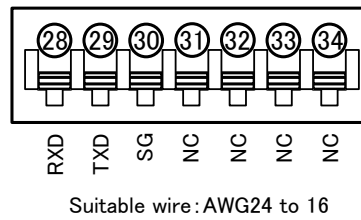

Figure 2.5 Wiring of RS-232C communication

Table 2.6 Connector contents

Terminal number	symbol	Contents
28	RXD	Receive terminal
29	TXD	Transmission terminal
30	SG	Common terminal of communication function
31~34	NC	Not connected * Please do not use as relay terminal.

2-4-2. Configuration diagram example

The configuration example of WPMZ - 1/3 is shown below.

Master and slave (module) are connected 1: 1.
 Specify "1" for the slave address of the Modbus protocol.

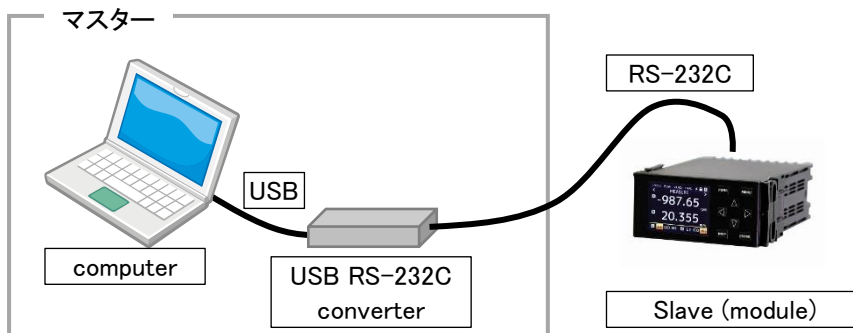

Figure 2.6 When USB-RS232C converter is used

3. Modbus communication specification

Modbus is a single master / multislave system.

A message is sent from one Modbus master to the slave (module). The message is sent to the specified slave (module).

3-1. Communication procedure

When the master sends a command message, the slave (module) sends a response message to the contents of the message.

The operations of the master side message and the slave side message are as follows.

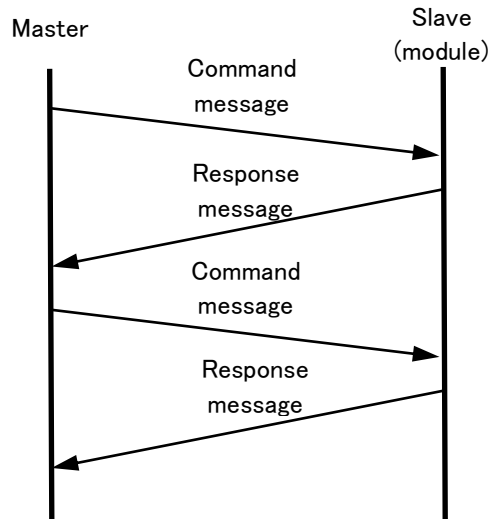
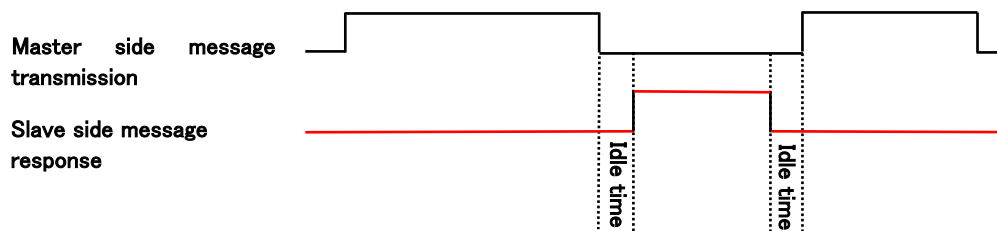

Figure 3.1 Communication procedure

3-2. Transmission Switching Time

In communication between master and slave, idle time for 3.5 characters is required for transmission / reception switching.



Please refer to the table below for the idle time for 3.5 characters.

In the WPMZ-1/3 series, the communication speed and parity setting can be changed.

Table 3.1 3.5 character idle time (reference value)

communication speed	With parity (Even number, odd number)	No parity
9600bps	4.01ms	3.65ms
19200bps	2.01ms	1.82ms
38400bps	1.00ms	0.91ms

3-3. Message

3-3-1. Composition of messages

After securing an idle interval of 3.5 character transmission time or longer, it transmits a communication message and ends after an idle time of 3.5 character transmission time or more.

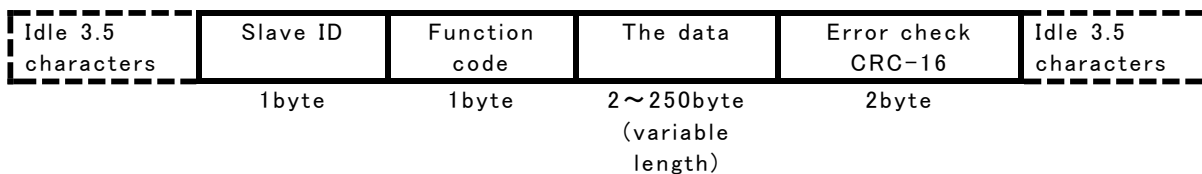

3-3-2. Message Contents

In the structure of the above message, descriptions of data and contents that can be set are shown in the table below.

Table 3.2 Message contents

item	Setting data	Contents
Slave ID	01~1FH	Slave ID (maximum number of connected units is 31)
Function code	03H	Read held register
	04H	Read input register (Read only address)
	06H	Hold register 1 word write
	08H	Diagnosis
	0BH	Read event counter
	0CH	Read event log
	10H	Holding register Continuous write
	11H	Read slave information
The data	—	Data (variable length by command)
Error check (CRC-16)	Calculate CRC-16 from the slave ID to the last byte of the data and add CRC-16 (2 bytes) of the operation result to the data in the order of the lower byte and the upper byte.	

3-3-3. Types of data

Modbus data has two input register and holding register.

Table 3.3 Types of data

Types of data	Reading and writing	Details
Input register	Read only	It is used to acquire the information in the slave.
Holding register	Reading and writing	It is used to acquire and set slave control information / setting information.

3-3-4. Slave ID

It returns a response message only when the received message matches the ID value set in the module.

If they do not match, no response message is returned.

3-3-5. Function code

The function code is a code that specifies the operation to be made slave, and it is included in the message sent from the master to the slave.

The function codes described in this manual are shown in the table below.

Table 3.4 Function code list

Function code	Feature Description
03H	Read held register
04H	Read input register (Read only address)
06H	Hold register 1 word write
08H	Diagnosis
10H	Holding register Continuous write

3-3-6. Format Details

Explain the detailed format for each function code.

⚠ Caution

Please be aware that the error checking CRC in each format is added in order of lower byte and higher byte.

1. Function code 03H (Read held register)

Read the parameter value of the specified address.

Transmission and reception format

◎Transmission data (master → slave (module))

Table 3.5 Function code 03H Transmission format

name		Transmitted data
Slave ID		01 ~ FFH
Function code		03H
Address	Upper	0000 ~ 270FH
	Lower	
Number of words to be read (Data length ÷ 2)	Upper	0001 ~ 007DH
	Lower	
Error check (CRC-16)	Upper	0000 ~ FFFFH
	Lower	

*Specify the number of read words in units of data length for each address.

◎Received data (slave (module) → master)

Table 3.6 Function code 03H Reception format

name		Received data
Slave ID		01 ~ FFH
Function code		03H
Number of bytes read		2 × number of read words
First word data	Upper	0000 ~ FFFFH
	Lower	
Next word data	Upper	0000 ~ FFFFH
	Lower	
?	?	?
The last word data	Upper	0000 ~ FFFFH
	Lower	
Error check (CRC-16)	Upper	0000 ~ FFFFH
	Lower	

2. Function code 04H (Read input register [Read only address])

Read the measurement value of the specified read-only address.

Transmission and reception format

◎Transmission data (master → slave (module))

Table 3.7 Function code 04H Transmission format

name		Transmitted data
Slave ID		01 ~ FFH
Function code		04H
Address	Upper	0000 ~ 270FH
	Lower	
Number of words to be read (Data length ÷ 2)	Upper	0001 ~ 007DH
	Lower	
Error check (CRC-16)	Lower	0000 ~ FFFFH
	Upper	

*Specify the number of read words in units of data length for each address.

◎Received data (slave (module) → master)

Table 3.8 Function code 04H Reception format

name		Received data
Slave ID		01 ~ FFH
Function code		04H
Number of bytes read		2 × number of read words
First word data	Upper	0000 ~ FFFFH
	Lower	
Next word data	Upper	0000 ~ FFFFH
	Lower	
⋮	⋮	⋮
The last word data	Upper	0000 ~ FFFFH
	Lower	
Error check (CRC-16)	Lower	0000 ~ FFFFH
	Upper	

3. Function code 06H (Write 1 word of holding register)

Writes 1 word (2 bytes) of data to the specified writable address.

Transmission and reception format

◎Transmission data (master → slave (module))

Table 3.9 Function code 06H Transmission format

name		Transmitted data
Slave ID		01 ~ FFH
Function code		06H
Address	Upper	0000 ~ 270FH
	Lower	
Write word data	Upper	0000 ~ FFFFH
	Lower	
Error check (CRC-16)	Lower	0000 ~ FFFFH
	Upper	

◎Received data (slave (module) → master)

Table 3.10 Function code 06H Reception format

name		Received data
Slave ID		01 ~ FFH
Function code		06H
Address	Upper	0000 ~ 270FH
	Lower	
Write word data	Upper	0000 ~ FFFFH
	Lower	
Error check (CRC-16)	Lower	0000 ~ FFFFH
	Upper	

Function code 08H (diagnosis)

It is a communication that diagnoses the communication between the master and the slave and diagnoses the module.

Transmission and reception format

ⓄTransmission data (master → slave (module))

Table 3.11 Function code 08H Transmission format

name		Transmitted data
Slave ID		01 ~ FFH
Function code		08H
Diagnostic subcode	Upper	0000 ~ 0012H
	Lower	
Data field	Upper	0000 ~ FFFFH
	Lower	
Error check (CRC-16)	Lower	0000 ~ FFFFH
	Upper	

ⓄReceived data (slave (module) → master)

Table 3.12 Function code 08H Reception format

name		Received data
Slave ID		01 ~ FFH
Function code		08H
Diagnostic subcode	Upper	0000 ~ 0015H
	Lower	
Data field	Upper	0000 ~ FFFFH
	Lower	
Error check (CRC-16)	Lower	0000 ~ FFFFH
	Upper	

Diagnostic subcode and diagnostic content

The corresponding diagnostic subcode is shown in the table below.

Table 3.13 Corresponding diagnostic subcode

Diagnostic subcode	Diagnostic name	Diagnosis contents
00H	Return Query Data	It returns the data of the transmitted data field as it is.
01H	Restart Communications Option	Restart communication.
02H	Return Diagnostics Register	Returns diagnostic register (fixed as 0 because it is not used).
04H	Force Listen Only Mode	Set the slave to receive only mode.
0AH	Clear Counters and Diagnostic Register	Clear all counters and diagnostic registers.
0BH	Return Bus Message Count	Returns the total of messages detected by the slave.
0CH	Return Bus Communication Error Count	Returns the total of CRC errors detected by the slave.
0DH	Return Bus Exception Error Count	Returns the sum of exception responses of Modbus returned by the specified slave.
0EH	Return Server Message Count	Returns the total of messages received by the specified slave.
0FH	Return Server No Response Count	Returns the total of messages for which the specified slave did not respond.
10H	Return Server NAK Count	Returns the total of messages that the specified slave returned NAK.

11H	Return Server Busy Count	Returns the number of times slave, busy, exception response returned by the specified slave.
12H	Return Bus Character Overrun Count	Returns the number of times a character overrun error occurred on the specified slave.

Diagnostic function communication example

Communication is performed with the diagnosis subcode 00H (Return Query Data) for the module with slave ID 01H.

An example of specifying 55AAH for write word data is shown below.

- Transmission data (master → slave (module))

Table 3.14 Function code 08H Transmission data

name		Transmitted data
Slave ID		01H
Function code		08H
Diagnostic subcode	Upper	00H
	Lower	00H
Data field	Upper	55H
	Lower	AAH
Error check (CRC-16)	Lower	5FH
	Upper	24H

- Received data (slave (module) → master)

Table 3.15 Function code 08H Receive data

name		Received data
Slave ID		01H
Function code		08H
Diagnostic subcode	Upper	00H
	Lower	00H
Data field	Upper	55H
	Lower	AAH
Error check (CRC-16)	Lower	5FH
	Upper	24H

1. Function code 10H (hold register consecutive write)

Writes contiguous data to the specified writable address.

Transmission and reception format

◎Transmission data (master → slave (module))

Table 3.16 Function code 10H Transmission format

name		Transmitted data
Slave ID		01 ~ FFH
Function code		10H
Start address	Upper	0000 ~ 270FH
	Lower	
The number of data	Upper	0002 ~ 01FEH
	Lower	
Number of bytes		01 ~ FFH
First write word data	Upper	0000 ~ FFFFH
	Lower	
Next write word data	Upper	0000 ~ FFFFH
	Lower	
?	?	?
Last write word data	Upper	0000 ~ FFFFH
	Lower	
Error check (CRC-16)	Lower	0000 ~ FFFFH
	Upper	

◎Received data (slave (module) → master)

Table 3.17 Function code 10H Reception format

name		Received data
Slave ID		01 ~ FFH
Function code		10H
Start address	Upper	0000 ~ 270FH
	Lower	
The number of data	Upper	0002 ~ 01FEH
	Lower	
Error check (CRC-16)	Lower	0000 ~ FFFFH
	Upper	

3-4. Error detection

3-4-1. CRC-16

CRC - 16 is 2 - byte error check data. The calculation range is from the slave ID at the head of the message to the end of the data part.

The slave (module) calculates the CRC of the received message, and if it does not match the received CRC code, it becomes no response and the function is not executed.

3-4-2. Calculation of CRC-16

To calculate the CRC, divide the transmission data by the generator polynomial ($X^{16} + X^{15} + X^2 + X^0$) and set the remainder in the order of the lower byte and upper byte in the error check.

The following is an example of generating with command data from the master device.

- ① Area initialization: Substitute FFFFH for 【CRC - 16】.
- ② Assign the calculated value of 【CRC - 16】 XOR 【first data (here, slave ID data)】 to 【CRC - 16】.
- ③ Assign [CRC - 16] to the right by one bit shifted to [CRC - 16].
- ④ If CF (carry flag) = 1, substitute the calculated value of [CRC - 16] XOR A 001 H into [CRC - 16] according to ③ above. (CF shifts to the right when shifting right one bit when the least significant bit is 1).
- ⑤ Repeat ③ and ④ above 8 times. After the end of 8 times, go to ⑥.
- ⑥ If the last data has been completed, add [CRC - 16] as a calculation result to the message and exit. If not finished, go to ⑦.
- ⑦ Assign the calculated value of 【CRC - 16】 XOR 【next data】 to 【CRC - 16】 and go to ③.

Calculation example: Perform CRC calculation of 01040000002.

Table 3.18 Calculated data example: 01040000002 (6 bytes data)

		16	15	14	13	12	11	10	9	8	7	6	5	4	3	2	1	CF	Description	
		1	1	1	1	1	1	1	1	1	1	1	1	1	1	1	1	1	—	FFFFH (initialization)
01 (1st byte)		0	0	0	0	0	0	0	0	0	0	0	0	0	0	0	1	—		
		1	1	1	1	1	1	1	1	1	1	1	1	1	1	1	0	—	XOR top two rows	
right shift 1st		0	1	1	1	1	1	1	1	1	1	1	1	1	1	1	1	0		
right shift 2nd		0	0	1	1	1	1	1	1	1	1	1	1	1	1	1	1	1	I	CF became 1
		1	0	1	0	0	0	0	0	0	0	0	0	0	0	0	1	—	A001H	
		1	0	0	1	1	1	1	1	1	1	1	1	1	1	1	0	—	XOR top two rows	
right shift 3rd		0	1	0	0	1	1	1	1	1	1	1	1	1	1	1	1	0		
right shift 4th		0	0	1	0	0	1	1	1	1	1	1	1	1	1	1	1	1	I	CF became 1
		1	0	1	0	0	0	0	0	0	0	0	0	0	0	0	1	—	A001H	
		1	0	0	0	0	1	1	1	1	1	1	1	1	1	1	0	—	XOR top two rows	
right shift 5th		0	1	0	0	0	0	1	1	1	1	1	1	1	1	1	1	0		
right shift 6th		0	0	1	0	0	0	0	1	1	1	1	1	1	1	1	1	1	I	CF became 1
		1	0	1	0	0	0	0	0	0	0	0	0	0	0	0	1	—	A001H	
		1	0	0	0	0	0	0	1	1	1	1	1	1	1	1	0	—	XOR top two rows	
right shift 7th		0	1	0	0	0	0	0	0	1	1	1	1	1	1	1	1	0		
right shift 8th		0	0	1	0	0	0	0	0	0	1	1	1	1	1	1	1	1	I	CF became 1
		1	0	1	0	0	0	0	0	0	0	0	0	0	0	0	1	—	A001H	
04 (2nd byte)		1	0	0	0	0	0	0	0	0	1	1	1	1	1	1	0	—	XOR top two rows	
		0	0	0	0	0	0	0	0	0	0	0	0	0	0	1	0	—		
right shift 1st		1	0	0	0	0	0	0	0	0	1	1	1	1	0	1	0	—	XOR top two rows	
right shift 2nd		0	1	0	0	0	0	0	0	0	0	1	1	1	1	0	1	0		
		0	0	1	0	0	0	0	0	0	0	0	1	1	1	1	0	I	CF became 1	
		1	0	1	0	0	0	0	0	0	0	0	0	0	0	0	1	—	A001H	
		1	0	0	0	0	0	0	0	0	0	0	1	1	1	1	1	—	XOR top two rows	
right shift 3rd		0	1	0	0	0	0	0	0	0	0	0	0	1	1	1	1	I	CF became 1	
		1	0	1	0	0	0	0	0	0	0	0	0	0	0	0	1	—	A001H	
		1	1	1	0	0	0	0	0	0	0	0	0	1	1	1	0	—	XOR top two rows	
right shift 4th		0	1	1	1	0	0	0	0	0	0	0	0	0	1	1	1	0		
right shift 5th		0	0	1	1	1	0	0	0	0	0	0	0	0	0	1	1	I	CF became 1	
		1	0	1	0	0	0	0	0	0	0	0	0	0	0	0	1	—	A001H	
		1	0	0	1	1	0	0	0	0	0	0	0	0	0	1	0	—	XOR top two rows	
right shift 6th		0	1	0	0	1	1	0	0	0	0	0	0	0	0	0	1	0		
right shift 7th		0	0	1	0	0	1	1	0	0	0	0	0	0	0	0	0	I	CF became 1	
		1	0	1	0	0	0	0	0	0	0	0	0	0	0	0	1	—	A001H	
		1	0	0	0	0	1	1	0	0	0	0	0	0	0	0	1	—	XOR top two rows	
right shift 8th		0	1	0	0	0	0	1	1	0	0	0	0	0	0	0	0	I	CF became 1	
		1	0	1	0	0	0	0	0	0	0	0	0	0	0	0	1	—	A001H	
00 (3rd byte)		1	1	1	0	0	0	1	1	0	0	0	0	0	0	0	1	—	XOR top two rows	
		0	0	0	0	0	0	0	0	0	0	0	0	0	0	0	0	—		
right shift 1st		1	1	1	0	0	0	1	1	0	0	0	0	0	0	0	1	—	XOR top two rows	
		0	1	1	1	0	0	0	1	1	0	0	0	0	0	0	0	I	CF became 1	
		1	0	1	0	0	0	0	0	0	0	0	0	0	0	0	1	—	A001H	
		1	1	0	1	0	0	0	1	1	0	0	0	0	0	0	1	—	XOR top two rows	
right shift 2nd		0	1	1	0	1	0	0	0	1	1	0	0	0	0	0	0	I	CF became 1	
		1	0	1	0	0	0	0	0	0	0	0	0	0	0	0	1	—	A001H	
		1	1	0	0	1	0	0	0	1	1	0	0	0	0	0	1	—	XOR top two rows	
right shift 3rd		0	1	1	0	0	1	0	0	0	1	1	0	0	0	0	0	I	CF became 1	
		1	0	1	0	0	0	0	0	0	0	0	0	0	0	0	1	—	A001H	
		1	1	0	0	0	1	0	0	0	1	1	0	0	0	0	1	—	XOR top two rows	

	16	15	14	13	12	11	10	9	8	7	6	5	4	3	2	1	CF	Description
																		rows
right shift 4th	0	1	1	0	0	0	1	0	0	0	1	1	0	0	0	0	1	CF became 1
	1	0	1	0	0	0	0	0	0	0	0	0	0	0	0	1	—	A001H
right shift 5th	1	1	0	0	0	0	1	0	0	0	1	1	0	0	0	1	—	XOR top two rows
	0	1	1	0	0	0	0	1	0	0	0	1	1	0	0	0	1	CF became 1
right shift 6th	1	0	1	0	0	0	0	0	0	0	0	0	0	0	0	1	—	A001H
	1	1	0	0	0	0	0	1	0	0	0	1	1	0	0	1	—	XOR top two rows
right shift 7th	0	1	1	0	0	0	0	0	0	1	0	0	0	1	1	0	1	CF became 1
	1	0	1	0	0	0	0	0	0	0	0	0	0	0	0	1	—	A001H
right shift 8th	1	1	0	0	0	0	0	0	0	1	0	0	0	1	1	1	—	XOR top two rows
	0	1	1	0	0	0	0	0	0	0	1	0	0	0	1	1	1	CF became 1
00 (4th byte)	1	0	1	0	0	0	0	0	0	0	0	0	0	0	0	1	—	A001H
	1	1	0	0	0	0	0	0	0	0	1	0	0	0	1	0	—	XOR top two rows
right shift 1st	0	1	1	0	0	0	0	0	0	0	0	1	0	0	0	1	0	
right shift 2nd	0	0	1	1	0	0	0	0	0	0	0	0	1	0	0	0	1	CF became 1
	1	0	1	0	0	0	0	0	0	0	0	0	0	0	0	1	—	A001H
right shift 3rd	1	0	0	1	0	0	0	0	0	0	0	0	1	0	0	1	—	XOR top two rows
	0	1	0	0	1	0	0	0	0	0	0	0	0	1	0	0	1	CF became 1
right shift 4th	1	0	1	0	0	0	0	0	0	0	0	0	0	0	0	1	—	A001H
	1	1	1	0	1	0	0	0	0	0	0	0	0	1	0	1	—	XOR top two rows
right shift 5th	0	1	1	0	1	0	1	0	0	0	0	0	0	0	0	1	1	CF became 1
	1	0	1	0	0	0	0	0	0	0	0	0	0	0	0	1	—	A001H
right shift 6th	1	1	0	0	1	0	1	0	0	0	0	0	0	0	0	0	—	XOR top two rows
	0	1	1	0	0	1	0	1	0	0	0	0	0	0	0	0	0	
right shift 7th	0	0	1	1	0	0	1	0	1	0	0	0	0	0	0	0	0	
right shift 8th	0	0	0	1	1	0	0	1	0	1	0	0	0	0	0	0	0	
00 (5th byte)	0	0	0	0	0	0	0	0	0	0	0	0	0	0	0	0	—	
right shift 1st	0	0	0	1	1	0	0	1	0	1	0	0	0	0	0	0	—	XOR top two rows
	0	0	0	0	1	1	0	0	1	0	1	0	0	0	0	0	0	
right shift 2nd	0	0	0	0	0	1	1	0	0	1	0	1	0	0	0	0	0	
right shift 3rd	0	0	0	0	0	0	1	1	0	0	1	0	1	0	0	0	0	
right shift 4th	0	0	0	0	0	0	1	1	0	0	1	0	1	0	0	0	0	
right shift 5th	0	0	0	0	0	0	0	1	1	0	0	1	0	1	0	0	0	
right shift 6th	0	0	0	0	0	0	0	0	1	1	0	0	1	0	1	0	0	
right shift 7th	0	0	0	0	0	0	0	0	0	0	1	1	0	0	1	0	1	CF became 1
	1	0	1	0	0	0	0	0	0	0	0	0	0	0	0	1	—	A001H
right shift 8th	1	0	1	0	0	0	0	0	0	0	1	1	0	0	1	1	—	XOR top two rows
	0	1	0	1	0	0	0	0	0	0	0	1	1	0	0	1	1	CF became 1
02 (6th byte)	1	0	1	0	0	0	0	0	0	0	0	0	0	0	0	1	—	A001H
	1	1	1	1	0	0	0	0	0	0	0	1	1	0	0	0	—	XOR top two rows
right shift 1st	0	1	1	1	1	0	0	0	0	0	0	1	1	0	1	0	0	
right shift 2nd	0	0	1	1	1	1	0	0	0	0	0	0	0	1	1	0	1	CF became 1
	1	0	1	0	0	0	0	0	0	0	0	0	0	0	0	1	—	A001H
	1	0	0	1	1	1	0	0	0	0	0	0	1	1	1	1	—	XOR top two rows

	16	15	14	13	12	11	10	9	8	7	6	5	4	3	2	1	CF	Description
right shift 3rd	0	1	0	0	1	1	1	0	0	0	0	0	0	0	1	1	I	CF became 1
	1	0	1	0	0	0	0	0	0	0	0	0	0	0	0	1	—	A001H
	1	1	1	0	1	1	1	0	0	0	0	0	0	0	1	0	—	XOR top two rows
right shift 4th	0	1	1	1	0	1	1	1	0	0	0	0	0	0	0	1	0	
right shift 5th	0	0	1	1	1	0	1	1	1	0	0	0	0	0	0	0	I	CF became 1
	1	0	1	0	0	0	0	0	0	0	0	0	0	0	0	1	—	A001H
	1	0	0	1	1	0	1	1	1	0	0	0	0	0	0	1	—	XOR top two rows
right shift 6th	0	1	0	0	1	1	0	1	1	1	0	0	0	0	0	0	I	CF became 1
	1	0	1	0	0	0	0	0	0	0	0	0	0	0	0	1	—	A001H
	1	1	1	0	1	1	0	1	1	1	0	0	0	0	0	1	—	XOR top two rows
right shift 7th	0	1	1	1	0	1	1	0	1	1	1	0	0	0	0	0	I	CF became 1
	1	0	1	0	0	0	0	0	0	0	0	0	0	0	0	1	—	A001H
	1	1	0	1	0	1	1	0	1	1	1	0	0	0	0	1	—	XOR top two rows
right shift 8th	0	1	1	0	1	0	1	1	0	1	1	1	0	0	0	0	I	CF became 1
	1	0	1	0	0	0	0	0	0	0	0	0	0	0	0	1	—	A001H
	1	1	0	0	1	0	1	1	0	1	1	1	0	0	0	1	—	XOR top two rows

The result of this CRC calculation is 1100101101110001. (Last line)

Displayed in hexadecimal notation is CB71H. (When you incorporate it into messages, it will be in order from lowest to highest)

3-5. Error Message

If there is an error in the message sent from the master, an error message is returned from the slave (module).

When an error message is returned, check the transmission data.

Table 3.19 Contents of error message (slave (module) → master)

name	
Slave ID	
Received function code + 80H	
Error code (see table below)	
Error check (CRC-16)	Lower
	Upper

Table 3.20 Error code contents

Error code	Contents	Description
01H	Function code defect	The module received a function code that does not correspond.
02H	Address problem	The module received a non-compliant address.
03H	Number of data errors	The specified number of data is too large.
06H	Slave busy	The module is busy.

©Error example

Response in case an address error occurs in the function code 04H from the module with the slave ID 01H

Table 3.21 Example of received data in case of error

name		Received data
Slave ID		01H
Function code		84H
Error code		02H
Error check (CRC-16)	Lower	C2H
	Upper	C1H

4. Communication example

The actual communication example of each message is shown below.

4-1. WPMZ-1/3

4-1-1. Acquire measurement data

When acquiring measurement data, it is as follows.

2. Data acquisition communication

Here is an example of obtaining display value of Ach.

The value is defined in the input register, so 04 H (input register readout [read only address]) is used as the function code.

Acquisition of display value of Ach (address: 00C9H)

First, send a message from the master to the slave (module).

Since the data size is 4 bytes, the number of read words is 2.

Table 4.1 Acquisition of display value of Ach [transmission]

Name		Transmitted Data
Slave ID		01H
Fuction code		04H
Address	Upper	00H
	Lower	C9H
Number of words to be read	Upper	00H
	Lower	02H
Error check (CRC-16)	Lower	A1H
	Upper	F5H

After that, 2 words of data are returned from the slave (module) to the master.

Table 4.2 Pulse input A Acquire instantaneous display value [reception]

Name		Received data
Slave ID		01H
Function code		04H
Number of bytes read		04H
Data of the first word	Upper	00H
	Lower	00H
Data of the second word	Upper	30H
	Lower	39H
Error check (CRC-16)	Lower	2FH
	Upper	96H

The acquired data is continued for two words, and it is as follows.

Table 4.3 Aquired data

Read value (hexadecimal number)	Decimal number
00003039	12345

4-1-2. Change control parameters

The simulation input / output control of the module is as follows.

1. Control parameter change communication

This example shows simulated output of the comparison output AL1.

Since the simulation output instruction of the comparison output AL1 is defined in the holding register, 10H (hold register consecutive writing) is used as the function code.

Comparative output AL1 simulated output (address: 03E8H)

First, send a message from the master to the slave (module).

Data write AL1 simulation output instruction: valid (0001H), indicated value: ON (0001H).

Since the number of words to be written is 2, the number of bytes to be written is 4.

Table 4.4 Comparative output AL1 simulated output [transmission]

name		Transmitted data
Slave ID		01H
Function code		10H
Start address	Upper	03H
	Lower	E8H
The number of data	Upper	00H
	Lower	02H
Number of bytes		04H
Data of the first word	Upper	00H
	Lower	01H
Data of the second word	Upper	00H
	Lower	01H
Error check (CRC-16)	Lower	78H
	Upper	B1H

Then the slave (module) will respond to the master.

Table 4.5 Comparative output AL1 simulated output [reception]

name		Received data
Slave ID		01H
Function code		10H
Address	Upper	03H
	Lower	E8H
The number of data	Upper	00H
	Lower	02H
Error check (CRC-16)	Lower	C1H
	Upper	B8H

4-1-3. Change setting parameters

To change the setting parameters, follow the steps below.

1. Setting permission communication

To change the setting value (address 0BC2H or later of the holding register), first specify setting permission.

Function code is 10H (hold register consecutive writing) is used.

Setting permission instruction (address: 0BB8H)

First, send a message from the master to the slave (module).

Data write setting permission (3333 CCCC).

Since the number of words to be written is 2, the number of bytes to be written is 4.

Table 4.6 Setting permission instruction [transmission]

name		Transmitted data
Slave ID		01H
Function code		10H
Start address	Upper	0BH
	Lower	B8H
The number of data	Upper	00H
	Lower	02H
Number of bytes		04H
Data of the first word	Upper	33H
	Lower	33H
Data of the second word	Upper	CCH
	Lower	CCH
Error check (CRC-16)	Lower	20H
	Upper	53H

Then the slave (module) will respond to the master.

When the following response is returned, the module is in the setting enable state.

Table 4.7 Setting permission instruction [reception]

Name		Received data
Slave ID		01H
Function code		10H
Address	Upper	0BH
	Lower	B8H
The number of data	Upper	00H
	Lower	02H
Error check (CRC-16)	Lower	C3H
	Upper	C9H

2. Setting value write communication

An example of changing "pulse input A pattern 1 input type" is shown below.

The function code is 06H (1-word holding register hold) or 10H (hold register continuous write).

Ach pattern 1 switching sensor power supply/bridge power supply (address:0EE3H)

First, send a message from the master to the slave (module).

Below is an example of switching sensor power supply to 24V by setting 0001H for the address when input type is process input.

Since the number of write words is 1, the write byte count is 2.

Table 4.8 Ach pattern 1 switching sensor power supply/bridge power supply writing [transmission]

Name		Transmitted data
Slave ID		01H
Function code		10H
Start address	Upper	0EH
	Lower	E3H
The number of data	Upper	00H
	Lower	01H
Number of bytes		02H
Data of the first word	Upper	00H
	Lower	01H
Error check (CRC-16)	Lower	9EH
	Upper	03H

Then the slave (module) will respond to the master.

If you specify a value outside the range or there is an error in the address, it will be an error response here, so you will need to redo the setting permission communication again.

Table 4.9 Ach pattern 1 switching sensor power supply/bridge power supply writing [reception]

Name		Received data
Slave ID		01H
Function code		10H
Address	Upper	0EH
	Lower	E3H
The number of data	Upper	00H
	Lower	01H
Error check (CRC-16)	Lower	F2H
	Upper	D7H

3. Setting save communication

When saving the changed setting value, it instructs save setting.
 Function code is 10H (hold register consecutive writing) is used.

Setting save instruction (address: 0BB8H)

First, send a message from the master to the slave (module).

Write setting permission (00000000H) for data.

Since the number of words to be written is 2, the number of bytes to be written is 4.

Table 4.10 Setting save instruction [transmission]

name		Transmitted data
Slave ID		01H
Function code		10H
Start address	Upper	0BH
	Lower	B8H
The number of data	Upper	00H
	Lower	02H
Number of bytes		04H
Data of the first word	Upper	00H
	Lower	00H
Data of the second word	Upper	00H
	Lower	00H
Error check (CRC-16)	Lower	8AH
	Upper	4DH

Then the slave (module) will respond to the master.

If it is not an error response, the setting value is updated normally.

In the case of an error response, it is necessary to redo the setting permission communication again.

Table 4.11 Setting save instruction [reception]

name		Received data
Slave ID		01H
Function code		10H
Address	Upper	0BH
	Lower	B8H
The number of data	Upper	00H
	Lower	02H
Error check (CRC-16)	Lower	C3H
	Upper	C9H

5. Address Map

Write the address map of each model.

5-1. WPMZ-1/3

This section describes the WPMZ-1/3 of the address map.

5-1-1. Setting and control parameters

1. Holding register

The hold register command is shown in the table below.

Table 5.1 Holding register command

Read command	03H
Write command	06H
Continuous write command	10H

Control parameters

The control parameters are as follows.

Please refer to "4-1-2. Change control parameters" when making mock input / output instruction from control parameters.

Table 5.2 Control parameters

Absolute address (Decimal number)	Communication address (Hexadecimal)	CH	Contents	Size (byte)	R/W	The data
40000 ~ 40102	0000H ~ 0065H	~	Reserved	~	~	
40103	0066H	-	Pattern select instruction	2	R/W	0000H: Disable, 0001H: Enable
40104	0067H	-	Pattern select instruction value	2	R/W	0000H: Pattern1, 0001H: Pattern2, 0002H: Pattern3, 0003H: Pattern4, 0004H: Pattern5, 0005H: Pattern6, 0006H: Pattern7, 0007H: Pattern8
40105	0068H	-	Relay reset instruction	2	R/W	0000H: Disable, 0001H: Enable
	0069H ~ 006EH	~	Reserved	~	~	
40112	006FH	-	DispHold A instruction	2	R/W	0000H: Disable, 0001H: Enable *2 *2 It works only when measure mode is "Default".
40113	0070H	-	DispHold B instruction	2	R/W	0000H: Disable, 0001H: Enable *1, 2 *1 It works only when 2 input product. *2 It works only when measure mode is "Default".
40114	0071H	-	DispHold A&B instruction	2	R/W	0000H: Disable, 0001H: Enable *1, 2 *1 It works only when 2 input product. *2 It works only when measure mode is "Default".
40115	0072H	-	MaxHold A instruction	2	R/W	0000H: Disable, 0001H: Enable *2 *2 It works only when measure mode is "Default".
40116	0073H	-	MaxHold B instruction	2	R/W	0000H: Disable, 0001H: Enable *1, 2 *1 It works only when 2 input product. *2 It works only when measure mode is "Default".
40117	0074H	-	MaxHold A&B instruction	2	R/W	0000H: Disable, 0001H: Enable *1, 2 *1 It works only when 2 input product. *2 It works only when measure mode is "Default".

40118	0075H	-	MinHold A instruction	2	R/W	0000H: Disable, 0001H: Enable *2 *2 It works only when measure mode is "Default".
40119	0076H	-	MinHold B instruction	2	R/W	0000H: Disable, 0001H: Enable *1, 2 *1 It works only when 2 input product. *2 It works only when measure mode is "Default".
40120	0077H	-	MinHold A&B instruction	2	R/W	0000H: Disable, 0001H: Enable *1, 2 *1 It works only when 2 input product. *2 It works only when measure mode is "Default".
40121	0078H	-	Display change instruction	2	R/W	0000H: Disable, 0001H: Enable (Automatically return to 0000H after execution.)
40122	0079H	-	TrendLog instruction	2	R/W	0000H: None 0001H: Instruction ON (Automatically return to 0000H after execution) *2 The trend data at the time of instruction is stored as an alarm log. When the overwrite setting is prohibited and all the alarm logs are filled, the instruction is ignored. *2 It works only when measure mode is "Default".
40123	007AH	-	DizitalZero A instruction	2	R/W	0000H: Disable, 0001H: Enable
40124	007BH	-	DizitalZero B instruction	2	R/W	0000H: Disable, 0001H: Enable *1 *1 It works only when 2 input product.
40125	007CH	-	DizitalZero A&B instruction	2	R/W	0000H: Disable, 0001H: Enable *1 *1 It works only when 2 input product.
40126	007DH	-	AmpHold A insruction	2	R/W	0000H: Disable, 0001H: Enable *2 *2 It works only when measure mode is "Default".
40127	007EH	-	AmpHold B insruction	2	R/W	0000H: Disable, 0001H: Enable *1, 2 *1 It works only when 2 input product. *2 It works only when measure mode is "Default".
40128	007FH	-	AmpHold A&B insruction	2	R/W	0000H: Disable, 0001H: Enable *1, 2 *1 It works only when 2 input product. *2 It works only when measure mode is "Default".
40129	0080H	-	DevHold A insruction	2	R/W	0000H: Disable, 0001H: Enable *2 *2 It works only when measure mode is "Default".
40130	0081H	-	DevHold B insruction	2	R/W	0000H: Disable, 0001H: Enable *1, 2 *1 It works only when 2 input product. *2 It works only when measure mode is "Default".
40131	0082H	-	DevHold A&B insruction	2	R/W	0000H: Disable, 0001H: Enable *1, 2 *1 It works only when 2 input product. *2 It works only when measure mode is "Default".
40132	0083H	-	AveHold A insruction	2	R/W	0000H: Disable, 0001H: Enable *2 *2 It works only when measure mode is "Default".
40133	0084H	-	AveHold B insruction	2	R/W	0000H: Disable, 0001H: Enable *1, 2 *1 It works only when 2 input product. *2 It works only when measure mode is "Default".
40134	0085H	-	AveHold A&B insruction	2	R/W	0000H: Disable, 0001H: Enable *1, 2 *1 It works only when 2 input product. *2 It works only when measure mode is "Default".

40135	0086H	-	HoldReset A insruction	2	R/W	0000H: Disable, 0001H: Enable
40136	0087H	-	HoldReset B insruction	2	R/W	0000H: Disable, 0001H: Enable *1 *1 It works only when 2 input product.
40137	0088H	-	HoldReset A&B insruction	2	R/W	0000H: Disable, 0001H: Enable *1 *1 It works only when 2 input product.
40138	008AH	-	AlarmLogClear	2	R/W	0000H: Disable, 0001H: Enable *2 (Automatically return to 0000H after execution) Erase all aralm logs when instructed. *2 It works only when measure mode is "Default".
40139	008BH	-	MultiHold A instruction	2	R/W	0000H: Disable, 0001H: Enable *1 *1 It works only when measure mode is "Multi".
40140	008CH	-	MultiHold B instruction	2	R/W	0000H: Disable, 0001H: Enable *1, 2 *1 It works only when 2 input product. *2 It works only when measure mode is "Multi".
40141	008DH	-	WaveCompare A instruction	2	R/W	0000H: Disable, 0001H: Enable *1 (Automatically return to 0000H after execution) *1 It works only when measure mode is "WaveCompare".
40142	008EH	-	WaveCompare B instruction	2	R/W	0000H: Disable, 0001H: Enable *1, 2 (Automatically return to 0000H after execution) *1 It works only when 2 input product. *2 It works only when measure mode is "WaveCompare".
40143	008FH	-	OK Wave A Erase	2	R/W	0000H: Disable, 0001H: Enable *1 (Automatically return to 0000H after execution) Erase OK all wave logs of Ach when instructed. *1 It works only when measure mode is "WaveCompare".
40144	0090H	-	NG Wave A Erase	2	R/W	0000H: Disable, 0001H: Enable *1 (Automatically return to 0000H after execution) Erase NG all wave logs of Ach when instructed. *1 It works only when measure mode is "WaveCompare".
40145	0091H	-	OK Wave B Erase	2	R/W	0000H: Disable, 0001H: Enable *1, 2 (Automatically return to 0000H after execution) Erase OK all wave logs of Bch when instructed. *1 It works only when 2 input product. *2 It works only when measure mode is "WaveCompare".
40146	0092H	-	NG Wave B Erase	2	R/W	0000H: Disable, 0001H: Enable *1, 2 (Automatically return to 0000H after execution) Erase NG all wave logs of Bch when instructed. *1 It works only when 2 input product. *2 It works only when measure mode is "WaveCompare".
40147 ~ 41000	0093H ~ 03E7H	~	Reserved	~	~	

●CompareAL1

41001	03E8H	AL 1	OutputTest instruction	2	R/W	0000H:Disable, 0001H:Enable
41002	03E9H	AL 1	OutputTest instruction value	2	R/W	0000H:OFF, 0001H:ON
41003 ~ 41050	03EAH ~ 0419H	~	Reserved	~	~	

●CompareAL2

41051	041AH	AL 2	OutputTest instruction	2	R/W	* Please refer to AL1.
41052	041BH	AL 2	OutputTest instruction value	2	R/W	* Please refer to AL1.
41053 ~ 41100	041CH ~ 044BH	~	Reserved	~	~	

●CompareAL3

41101	044CH	AL 3	OutputTest instruction	2	R/W	*Please refer to AL1.
41102	044DH	AL 3	OutputTest instruction value	2	R/W	*Please refer to AL1.
41103 ~ 41150	044EH ~ 047DH	~	Reserved	~	~	

●CompareAL4

41151	047EH	AL 4	OutputTest instruction	2	R/W	*Please refer to AL1.
41152	047FH	AL 4	OutputTest instruction value	2	R/W	*Please refer to AL1.
41153 ~ 41160	0480H ~ 0487H	~	Reserved	~	~	

●Ach GO output

41161	0488H	Ac h	OutputTest instruction	2	R/W	0000H:Disable, 0001H:Enable
41162	0489H	Ac h	OutputTest instruction value	2	R/W	0000H:OFF, 0001H:ON
41163 ~ 41170	048AH ~ 0491H	~	Reserved	~	~	

●Bch GO output

41171	0492H	Bc h	OutputTest instruction	2	R/W	0000H:Disable, 0001H:Enable
41172	0493H	Bc h	OutputTest instruction value	2	R/W	0000H:OFF, 0001H:ON
41173 ~ 43000	0494H ~ 0BB7H	~	Reserved	~	~	

Setting parameters

Setting parameters are shown below.

Please refer to "4-1-3. Change setting parameters" when changing setting parameters.

Table 5.3 Setting parameters

Absolute address (Decimal number)	Communication address (Hexadecimal)	CH	Contents	Size (byte)	R/W	The data
43001	0BB8H	-	Setting permission / save instruction	4	W	3333 CCCCH: Permit 0000 0000H: Save instruction
43003	0BBAH	-	Error contents	2	R	0000H: No error, Other than 0000H: Error occurred *Please refer to error code. (Table 5.4)
43004 ~ 43810	0BBBH ~ 0EE1H	~	Reserved	~	~	

●Ach input setting

Pattern1

43811	0EE2 H	Ach	InputRange	2	R/W	【Input : Process】 0000H: 0-5V 0001H: 1-5V 0002H: ±5V 0003H: 0-10V 0004H: ±10V 0005H: 0-20mA 0006H: 4-20mA 0007H: ±20mA 【Input : Straingauge】 0000H: ±3.5mV/V 【Input : DC】 0~7: Not defined. (Do not work)
43812	0EE3 H	Ach	SensorPower/BridgeExcitation	2	R/W	【Input : Process or DC】 0000H: 12V 0001H: 24V 【Input : Straingauge】 0000H: 2.5V 0001H: 5.0V 0002H: 10.0V
43813	0EE4 H	Ach	AnalogFilter	2	R/W	【Input : Process or DC】 0000H: OFF 【Input : Straingauge】 0000H: OFF 0001H: 600Hz 0002H: 300Hz 0003H: 30Hz
43814	0EE5 H	Ach	SamplingRate	2	R/W	0000H: 4000sps *1, 0001H: 2000sps, 0002H: 1000sps, 0003H: 500sps, 0004H: 200sps, 0005H: 100sps, 0006H: 50sps, 0007H: 20sps, 0008H: 10sps, 0009H: 5sps, 000AH: 2sps, 000BH: 1sps, *1 Settable only 1ch product
43815	0EE6 H	Ach	MoveAve	2	R/W	0000H: None, 0001H: 2times, 0002H: 4times, 0003H: 8times, 0004H: 16times, 0005H: 32times, 0006H: 64times
43816	0EE7 H	Ach	Offset: Input / AutoAdjust: NowDisp / ManuAdjust: NowDisp	4	R/W	±99999
43818	0EE9 H	Ach	Offset: Disp / AutoAdjust: (Execute) / ManuAdjust: (Execute)	4	R/W	±99999 *1 *1 If input type is straingauge, only "0" can be settable.

43820	0EEB H	Ach	Offset: Input / AutoAdjust: NowDisp / ManuAdjust: RateOutput	4	R/ W	±99999
43822	0EED H	Ach	Offset: Disp / AutoAdjust: SettingDisp / ManuAdjust: SettingDisp	4	R/ W	±99999
43824	0EEF H	Ach	DecPoint	2	R/ W	0000H: ##### 0001H: ##### # 0002H: ###.### 0003H: ##.#### 0004H: #.#####
43825	0EF0 H	Ach	DispUnit	2	R/ W	0000H: None, 0002H: mA, 0004H: kA, 0006H: mV, 0008H: kV, 000AH: W, 000CH: MW, 000EH: mm, 0010H: m, 0012H: kΩ, 0014H: g, 0016H: N, 0018H: MN, 001AH: kPa, 001CH: hPa, 001EH: kJ, 0020H: Hz, 0022H: MHz, 0024H: mm/s, 0026H: cm/min, 0028H: m/min, 002AH: m/s ² , 002CH: m ³ /min, 002EH: kg/h, 0030H: kg/m ³ , 0032H: ℓ, 0034H: ℓ/min, 0036H: %, 0038H: %RH, 003AH: ph, 003CH: rpm, 003EH: inch, 0001H: μA, 0003H: A, 0005H: μV, 0007H: V, 0009H: VA, 000BH: kW, 000DH: μm, 000FH: cm, 0011H: Ω, 0013H: MΩ, 0015H: kg, 0017H: kN, 0019H: Pa, 001BH: Mpa, 001DH: J, 001FH: MJ, 0021H: kHz, 0023H: m ³ , 0025H: mm/min, 0027H: m/s, 0029H: m/h 002BH: m ³ /s, 002DH: m ³ /h, 002FH: kg/m ² , 0031H: N/m ² , 0033H: ℓ/s, 0035H: ℓ/h, 0037H: ‰, 0039H: °C, 003BH: ppm, 003DH: t, 003FH: CustomUnit
43826	0EF1 H	Ach	1 st letter of custom unit	2	R/ W	0000H: None, 0002H: b, 0004H: d, 0006H: f, 0008H: h, 000AH: j, 000CH: l, 000EH: n, 0010H: p, 0012H: r, 0014H: t, 0016H: v, 0018H: x, 001AH: z, 001CH: B, 001EH: D, 0020H: F, 0022H: H, 0024H: J, 0026H: L, 0028H: N, 002AH: P, 002CH: R, 002EH: T, 0030H: V, 0032H: X, 0001H: a, 0003H: c, 0005H: e, 0007H: g, 0009H: i, 000BH: k, 000DH: m, 000FH: o, 0011H: q, 0013H: s, 0015H: u, 0017H: w, 0019H: y, 001BH: A, 001DH: C, 001FH: E, 0021H: G, 0023H: I, 0025H: K, 0027H: M, 0029H: O, 002BH: Q, 002DH: S, 002FH: U, 0031H: W, 0033H: Y,

						0034H:Z, 0036H:], 0038H:), 003AH:2, 003CH:1, 003EH:3, 0040H:μ, 0042H:g, 0044H:/, 0046H:%, 0048H:°, 004AH:”	0035H:[, 0037H:(, 0039H:1, 003BH:3, 003DH:2, 003FH:~, 0041H:Ω, 0043H:*, 0045H:ℓ, 0047H:‰, 0049H:’
43827	0EF2 H	Ach	2 nd letter of custom unit	2	R/ W	Same as 1st letter.	
43828	0EF3 H	Ach	3 rd letter of custom unit	2	R/ W	Same as 1st letter.	
43829	0EF4 H	Ach	4 th letter of custom unit	2	R/ W	Same as 1st letter.	
43830	0EF5 H	Ach	5 th letter of custom unit	2	R/ W	Same as 1st letter.	
43831	0EF6 H	Ach	6 th letter of custom unit	2	R/ W	Same as 1st letter.	
43832	0EF7 H	Ach	DispShift	4	R/ W	±99999	
43834	0EF9 H	Ach	TrackingZero: Interval	2	R/ W	0~9999 [×0.01sec]	
43835	0EFA H	Ach	TrackingZero: ActiveArea	4	R/ W	0~99999	
43837	0EFC H	Ach	DispLimit: LoewrLimit	4	R/ W	0~99999 With range check before saving.	
43839	0EFE H	Ach	DispLimit: UpperLimit	4	R/ W	0~99999 With range check before saving.	
43841	0F00 H	Ach	DispLoCut	4	R/ W	0~99999[×digit]	
43843	0F02 H	Ach	InsDispStep	2	R/ W	0000H: None 0001H: 5step 0002H: 10step	
43844	0F03 H	Ach	InputCorrect	2	R/ W	0000H: None 0001H: Linearize	
43845	0F04 H	Ach	LinearizePoint: 1stInput	4	R/ W	±99999[×digit] With range check before saving.	
43847	0F06 H	Ach	LinearizePoint: 1stOutput	4	R/ W	±99999[×digit]	
43849	0F08 H	Ach	LinearizePoint: 2ndInput	4	R/ W	±99999[×digit] With range check before saving.	
43851	0F0A H	Ach	LinearizePoint: 2ndOutput	4	R/ W	±99999[×digit]	
43853	0F0C H	Ach	LinearizePoint: 3rdInput	4	R/ W	±99999[×digit] With range check before saving.	
43855	0F0E H	Ach	LinearizePoint: 3rdOutput	4	R/ W	±99999[×digit]	
43857	0F10 H	Ach	LinearizePoint: 4thInput	4	R/ W	±99999[×digit] With range check before saving.	
43859	0F12 H	Ach	LinearizePoint: 4thOutput	4	R/ W	±99999[×digit]	
43861	0F14 H	Ach	LinearizePoint: 5thInput	4	R/ W	±99999[×digit] With range check before saving.	
43863	0F16 H	Ach	LinearizePoint: 5thOutput	4	R/ W	±99999[×digit]	
43865	0F18 H	Ach	LinearizePoint: 6thInput	4	R/ W	±99999[×digit] With range check before saving.	
43867	0F1A H	Ach	LinearizePoint: 6thOutput	4	R/ W	±99999[×digit]	
43869	0F1C H	Ach	LinearizePoint: 7thInput	4	R/ W	±99999[×digit] With range check before saving.	
43871	0F1E H	Ach	LinearizePoint: 7thOutput	4	R/ W	±99999[×digit]	
43873	0F20 H	Ach	LinearizePoint: 8thInput	4	R/ W	±99999[×digit] With range check before saving.	
43875	0F22 H	Ach	LinearizePoint: 8thOutput	4	R/ W	±99999[×digit]	

43877	0F24 H	Ach	LinearizePoint: 9thInput	4	R/ W	±99999[xdigit] With range check before saving.
43879	0F26 H	Ach	LinearizePoint: 9thOutput	4	R/ W	±99999[xdigit]
43881	0F28 H	Ach	LinearizePoint: 10thInput	4	R/ W	±99999[xdigit] With range check before saving.
43883	0F2A H	Ach	LinearizePoint: 10thOutput	4	R/ W	±99999[xdigit]
43885	0F2C H	Ach	LinearizePoint: 11thInput	4	R/ W	±99999[xdigit] With range check before saving.
43887	0F2E H	Ach	LinearizePoint: 11thOutput	4	R/ W	±99999[xdigit]
43889	0F30 H	Ach	LinearizePoint: 12thInput	4	R/ W	±99999[xdigit] With range check before saving.
43891	0F32 H	Ach	LinearizePoint: 12thOutput	4	R/ W	±99999[xdigit]
43893	0F34 H	Ach	LinearizePoint: 13thInput	4	R/ W	±99999[xdigit] With range check before saving.
43895	0F36 H	Ach	LinearizePoint: 13thOutput	4	R/ W	±99999[xdigit]
43897	0F38 H	Ach	LinearizePoint: 14thInput	4	R/ W	±99999[xdigit] With range check before saving.
43899	0F3A H	Ach	LinearizePoint: 14thOutput	4	R/ W	±99999[xdigit]
43901	0F3C H	Ach	LinearizePoint: 15thInput	4	R/ W	±99999[xdigit] With range check before saving.
43903	0F3E H	Ach	LinearizePoint: 15thOutput	4	R/ W	±99999[xdigit]
43905	0F40 H	Ach	LinearizePoint: 16thInput	4	R/ W	±99999[xdigit] With range check before saving.
43907	0F42 H	Ach	LinearizePoint: 16thOutput	4	R/ W	±99999[xdigit]
43909	0F44 H	Ach	ZeroArea	4	R/ W	0~99999 *1 *1 It works only when measure mode is "Default".
43911	0F46 H	Ach	StableArea	4	R/ W	0~99999 *1 *1 It works only when measure mode is "Default".
43913	0F48 H	Ach	StableTime	2	R/ W	0~9999[×0.01sec] *1 *1 It works only when measure mode is "Default".
43914 ~ 43940	0F49H ~ 0F63H	~	Reserved	~	~	

Pattern2: Communication address is absolute address of pattern1 +130 , and the data is same as pattern1.

Pattern3: Communication address is absolute address of pattern1 +260 , and the data is same as pattern1.

Pattern4: Communication address is absolute address of pattern1 +390 , and the data is same as pattern1.

Pattern5: Communication address is absolute address of pattern1 +520 , and the data is same as pattern1.

Pattern6: Communication address is absolute address of pattern1 +650 , and the data is same as pattern1.

Pattern7: Communication address is absolute address of pattern1 +780 , and the data is same as pattern1.

Pattern8: Communication address is absolute address of pattern1 +910 , and the data is same as pattern1.

●Bch input setting

Pattern1: Communication address is absolute address of pattern1 of Ach input setting +1040, and the data is same as pattern1 of Ach input setting.

Pattern2: Communication address is absolute address of pattern1 of Ach input setting +1170, and the data is same as pattern1 of Ach input setting.

Pattern3: Communication address is absolute address of pattern1 of Ach input setting +1300, and the data is same as pattern1 of Ach input setting.

Pattern4: Communication address is absolute address of pattern1 of Ach input setting +1430, and the data is same as pattern1 of Ach input setting.

Pattern5: Communication address is absolute address of pattern1 of Ach input setting +1560, and the data is same as pattern1 of Ach input setting.

Pattern6: Communication address is absolute address of pattern1 of Ach input setting +1690, and the data is same as pattern1 of Ach input setting.

Pattern7: Communication address is absolute address of pattern1 of Ach input setting +1820, and the data is same as pattern1 of Ach input setting.

Pattern8: Communication address is absolute address of pattern1 of Ach input setting +1950, and the data is same as pattern1 of Ach input setting.

●Calculation setting

Pattern1

45891	1702 H	-	Expression	2	R/ W	0000H: None 0001H: Add 0002H: Sub 0003H: Mul 0004H: Div 0005H: Ave 0006H: HiSelect 0007H: LoSelect 0008H: DifAbs 0009H: ErrRatio 000AH: Dens 000BH: Add2 000CH: Sub2 000DH: Mul2 000EH: Div2 * It works only when measure mode is "Default"
45892	1703 H	-	Const-C: Exponent part	4	R/ W	±99999 (x0.00001)
45894	1705 H	-	Const-C: Mantissa part	2	R/ W	±5
45895	1706 H	-	Coef-K	4	R/ W	±99999 (x0.00001)
45897	1708 H	-	DecPoint (Calculation setting)	2	R/ W	0000H: ##### 0001H: #####.# 0002H: ###.### 0003H: ##.### 0004H: #.#####
45898	1709 H	-	DispUnit (Calculation setting)	2	R/ W	0000H: None, 0002H: mA, 0004H: kA, 0006H: mV, 0008H: kV, 000AH: W, 000CH: MW, 000EH: mm, 0010H: m, 0012H: kΩ, 0014H: g, 0016H: N, 0018H: MN, 001AH: kPa, 001CH: hPa, 001EH: kJ, 0020H: Hz, 0022H: MHz, 0024H: mm/s, 0026H: cm/min, 0028H: m/min, 002AH: m/s ² , 002CH: m ³ /min, 002EH: kg/h, 0030H: kg/m ³ , 0032H: ℓ, 0034H: ℓ/min, 0036H: %, 0038H: %RH, 003AH: ph, 003CH: rpm, 003EH: inch, 0001H: μA, 0003H: A, 0005H: μV, 0007H: V, 0009H: VA, 000BH: kW, 000DH: μm, 000FH: cm, 0011H: Ω, 0013H: MΩ, 0015H: kg, 0017H: kN, 0019H: Pa, 001BH: Mpa, 001DH: J, 001FH: MJ, 0021H: kHz, 0023H: m ³ , 0025H: mm/min, 0027H: m/s, 0029H: m/h, 002BH: m ³ /s, 002DH: m ³ /h, 002FH: kg/m ² , 0031H: N/m ² , 0033H: ℓ/s, 0035H: ℓ/h, 0037H: ‰, 0039H: °C, 003BH: ppm, 003DH: t, 003FH: CustomUnit
45899	170A H	-	1 st letter of custom unit	2	R/ W	0000H: None, 0002H: b, 0004H: d, 0006H: f, 0008H: h, 000AH: j, 000CH: l, 000EH: n, 0001H: a, 0003H: c, 0005H: e, 0007H: g, 0009H: i, 000BH: k, 000DH: m, 000FH: o,

						0010H:p, 0012H:r, 0014H:t, 0016H:v, 0018H:x, 001AH:z, 001CH:B, 001EH:D, 0020H:F, 0022H:H, 0024H:J, 0026H:L, 0028H:N, 002AH:P, 002CH:R, 002EH:T, 0030H:V, 0032H:X, 0034H:Z, 0036H:], 0038H:), 003AH:², 003CH:¹, 003EH:³, 0040H:µ, 0042H:g, 0044H:/, 0046H:%, 0048H:°, 004AH:”	0011H:q, 0013H:s, 0015H:u, 0017H:w, 0019H:y, 001BH:A, 001DH:C, 001FH:E, 0021H:G, 0023H:I, 0025H:K, 0027H:M, 0029H:O, 002BH:Q, 002DH:S, 002FH:U, 0031H:W, 0033H:Y, 0035H:[, 0037H:(, 0039H:₁, 003BH:₃, 003DH:², 003FH:·, 0041H:Ω, 0043H:·, 0045H:ℓ, 0047H:%₀, 0049H:’
45900	170B H	-	2 nd letter of custom unit	2	R/ W	Same as 1st letter.	
45901	170C H	-	3 rd letter of custom unit	2	R/ W	Same as 1st letter.	
45902	170D H	-	4 th letter of custom unit	2	R/ W	Same as 1st letter.	
45903	170E H	-	5 th letter of custom unit	2	R/ W	Same as 1st letter.	
45904	170F H	-	6 th letter of custom unit	2	R/ W	Same as 1st letter.	
45905	1710 H	-	DispStep (Calculation setting)	2	R/ W	0000H: None 0001H: 5step 0002H: 10step	
45906	1711 H	-	DispLimit: LowerLimit (Calculation setting)	4	R/ W	±99999 *With range check before saving.	
45908	1713 H	-	DispLimit: UpperLimit (Calculation setting)	4	R/ W	±99999 *With range check before saving.	
45910 ~ 45920	1715H ~ 171FH	~	Reserved	~	~	-	

Pattern2: Communication address is absolute address of pattern1 +30 , and the data is same as pattern1.

Pattern3: Communication address is absolute address of pattern1 +60 , and the data is same as pattern1.

Pattern4: Communication address is absolute address of pattern1 +90 , and the data is same as pattern1.

Pattern5: Communication address is absolute address of pattern1 +120 , and the data is same as pattern1.

Pattern6: Communication address is absolute address of pattern1 +150 , and the data is same as pattern1.

Pattern7: Communication address is absolute address of pattern1 +180 , and the data is same as pattern1.

Pattern8: Communication address is absolute address of pattern1 +210 , and the data is same as pattern1.

● External control setting

46131	17F2H	-	ExtCtrl1Func	2	R/ W	*1 0000H: None 0001H: Compare Reset 0002H: HoldReset A 0003H: HoldReset B 0004H: HoldReset A&B 0005H: DispHold A *2 0006H: DispHold B *2 0007H: DispHold A&B *2
-------	-------	---	--------------	---	---------	---

						0008H: MaxHold A *2 0009H: MaxHold B *2 000AH: MaxHold A&B *2 000BH: MinHold A *2 000CH: MinHold B *2 000DH: MinHold A&B *2 000EH: AmpHold A *2 000FH: AmpHold B *2 0010H: AmpHold A&B *2 0011H: DevHold A *2 0012H: DevHold B *2 0013H: DevHold A&B *2 0014H: AveHold A *2 0015H: AveHold B *2 0016H: AveHold A&B *2 0017H: DigitalZero A 0018H: DigitalZero B 0019H: DigitalZero A&B 001AH: DispChange 001BH: TrendLog *2 001CH: PatternChange 1 001DH: PatternChange 2 001EH: PatternChange 3 001FH: MultiHold A *3 0020H: MultiHold B *3 0021H: WaveCompare A *4 0022H: WaveCompare B *4 *1: Commands that are like [xxxB] or [xxxA&B] are settable when 2 input product. *2: It works only when measure mode is "Default". *3: It works only when measure mode is "WaveCompare". *4: It works only when measure mode is "Multi". With range check before saving.
46132	17F3H	-	ExtCtrl2Func	2	R/ W	*Please refer to ExtCtrl1Func.
46133	17F4H	-	ExtCtrl3Func	2	R/ W	*Please refer to ExtCtrl1Func.
46134	17F5H	-	ExtCtrl4Func	2	R/ W	*Please refer to ExtCtrl1Func.
46135	17F6H	-	ExtCtrl5Func	2	R/ W	*Please refer to ExtCtrl1Func.
46136 ~ 46140	17F7H ~ 17FBH	~	Reserved	~	~	

●Compare output AL1 setting

Pattern1

46141	17FCH	AL1	OutputDispValue (Compare output AL1)	2	R/ W	0000H: None 0001H: Ach 0002H: Beh *1 0003H: Calc *1,2 *1: It works only 2ch product. *2: It works only when measure mode is "Default".
46142	17FDH	AL1	CompareMode	2	R/ W	0000H: LevelJudge 0001H: ZoneJudge 0002H: DiffJudge * It works only when measure mode is "Default".
46143	17FEH	AL1	OnConditions (LevelJudge)	2	R/ W	0000H: Excess, 0001H: LessThan
46144	17FFH	AL1	Threshold: Threshold (LevelJudge)	4	R/ W	±99999 * It works only when measure mode is "Default".
46146	1801H	AL1	Threshold:Hysterisis (LevelJudge)	4	R/ W	0~99999

46148	1803H	AL1	OnConditions (ZoneJudge)	2	R/W	0000H: InTheZone, 0001H: OutsideTheZone
46149	1804H	AL1	Threshold: ZoneLowerLimit (ZoneJudge)	4	R/W	±99999 * It works only when measure mode is "Default".
46151	1806H	AL1	Threshold: ZoneUpperLimit (ZoneJudge)	4	R/W	±99999 * It works only when measure mode is "Default".
46153	1808H	AL1	Threshold: Hysteriis (ZoneJudge)	4	R/W	0~99,999
46155	180AH	AL1	OnDelay	2	R/W	0000H: None, 0001H: 20ms, 0002H: 50ms, 0003H: 100ms, 0004H: 200ms, 0005H: 500ms, 0006H: 1s, 0007H: 5s, 0008H: 10s, 0009H: 20s * It works only when measure mode is "Default".
46156	180BH	AL1	OffDelay	2	R/W	0000H: None, 0001H: 20ms, 0002H: 50ms, 0003H: 100ms, 0004H: 200ms, 0005H: 500ms, 0006H: 1s, 0007H: 5s, 0008H: 10s, 0009H: 20s * It works only when measure mode is "Default".
46157	180CH	AL1	OutputMode	2	R/W	0000H: Normal, 0001H: Latch, 0002H: OneShot 5ms, 0003H: OneShot 10ms, 0004H: OneShot 20ms, 0005H: OneShot 50ms, 0006H: OneShot 0.1s, 0007H: OneShot 0.2s, 0008H: OneShot 0.5s, 0009H: OneShot 1s, 000AH: OneShot 2s * It works only when measure mode is "Default".
46158	180DH	AL1	OutputLogic	2	R/W	0000H: Positive, 0001H: Negative
46159	180EH	AL1	OnBgColors	2	R/W	0000H: Black, 0001H: Red 0002H: Yellow, 0003H: Green
46160	180FH	AL1	ActCondition	2	R/W	0000H: Always 0001H: ExceptNearZero 0002H: OnStable 0003H: OnStableExceptNearZero 0004H: OnHold * It works only when measure mode is "Default".
46161	1810H	AL1	Threshold: ChangeAmount (DiffJudge)	4	R/W	±99999 * It works only when measure mode is "Default".
46163	1812H	AL1	Threshold: ActiveInterval (DiffJudge)	2	R/W	0~9999 [×0.01sec] * It works only when measure mode is "Default".
46164 ~ 46170	1813H ~ 1819H	~	Reserved	~	~	

- Pattern2:** Communication address is absolute address of pattern1 +30 , and the data is same as pattern1.
Pattern3: Communication address is absolute address of pattern1 +60 , and the data is same as pattern1.
Pattern4: Communication address is absolute address of pattern1 +90 , and the data is same as pattern1.
Pattern5: Communication address is absolute address of pattern1 +120 , and the data is same as pattern1.
Pattern6: Communication address is absolute address of pattern1 +150 , and the data is same as pattern1.
Pattern7: Communication address is absolute address of pattern1 +180 , and the data is same as pattern1.
Pattern8: Communication address is absolute address of pattern1 +210 , and the data is same as pattern1.

●Compare output AL2 setting

- Pattern1:** Communication address is absolute address of pattern1of AL1+240 , and the data is same.
- Pattern2:** Communication address is absolute address of pattern1of AL1+270 , and the data is same.
- Pattern3:** Communication address is absolute address of pattern1of AL1+300 , and the data is same.
- Pattern4:** Communication address is absolute address of pattern1of AL1+330 , and the data is same.
- Pattern5:** Communication address is absolute address of pattern1of AL1+360 , and the data is same.
- Pattern6:** Communication address is absolute address of pattern1of AL1+390 , and the data is same.
- Pattern7:** Communication address is absolute address of pattern1of AL1+420 , and the data is same.
- Pattern8:** Communication address is absolute address of pattern1of AL1+450 , and the data is same.

●Compare output AL3 setting

- Pattern1:** Communication address is absolute address of pattern1of AL1+480 , and the data is same.
- Pattern2:** Communication address is absolute address of pattern1of AL1+510 , and the data is same.
- Pattern3:** Communication address is absolute address of pattern1of AL1+540 , and the data is same.
- Pattern4:** Communication address is absolute address of pattern1of AL1+570 , and the data is same.
- Pattern5:** Communication address is absolute address of pattern1of AL1+600 , and the data is same.
- Pattern6:** Communication address is absolute address of pattern1of AL1+630 , and the data is same.
- Pattern7:** Communication address is absolute address of pattern1of AL1+660 , and the data is same.
- Pattern8:** Communication address is absolute address of pattern1of AL1+690 , and the data is same.

●Compare output AL4 setting

- Pattern1:** Communication address is absolute address of pattern1of AL1+720 , and the data is same.
- Pattern2:** Communication address is absolute address of pattern1of AL1+750 , and the data is same.
- Pattern3:** Communication address is absolute address of pattern1of AL1+780 , and the data is same.
- Pattern4:** Communication address is absolute address of pattern1of AL1+810 , and the data is same.
- Pattern5:** Communication address is absolute address of pattern1of AL1+840 , and the data is same.
- Pattern6:** Communication address is absolute address of pattern1of AL1+870 , and the data is same.
- Pattern7:** Communication address is absolute address of pattern1of AL1+900 , and the data is same.
- Pattern8:** Communication address is absolute address of pattern1of AL1+930 , and the data is same.

●Analog output setting

Pattern1

47261	1C5CH	-	OutputRange	2	R/ W	0000H: 0-10V 0001H: ±10V 0002H: 1-5V 0003H: 0-20mA 0004H: 4-20mA
47262	1C5DH	-	OutputDispValue (Analog output)	2	R/ W	0000H: None 0001H: Ach 0002H: Bch *1 0003H: Calc *1,2 *1: It works only 2ch product. *2: It works only when measure mode is "Default".
47263	1C5EH	-	OutputScale: 100%	4	R/ W	±99999 With range check before saving.
47265	1C60H	-	OutputScale: 0%	4	R/ W	±99999 With range check before saving.
47267 ~ 47270	1C62H ~ 1C65H	~	Reserved	~	~	

- Pattern2:** Communication address is absolute address of pattern1 +10 , and the data is same as pattern1.
- Pattern3:** Communication address is absolute address of pattern1 +20 , and the data is same as pattern1.
- Pattern4:** Communication address is absolute address of pattern1 +30 , and the data is same as pattern1.
- Pattern5:** Communication address is absolute address of pattern1 +40 , and the data is same as pattern1.
- Pattern6:** Communication address is absolute address of pattern1 +50 , and the data is same as pattern1.
- Pattern7:** Communication address is absolute address of pattern1 +60 , and the data is same as pattern1.
- Pattern8:** Communication address is absolute address of pattern1 +70 , and the data is same as pattern1.

●BCD output setting

Pattern1

47341	1CACH	-	OutputDispValue (BCD output)	2	R/ W	0000H: None 0001H: Ach 0002H: Bch *1 0003H: Calc *1,2 *1: It works only 2ch product. *2: It works only when measure mode is "Default".
47342	1CADH	-	DataSignalLogic	2	R/ W	0000H: Positive 0001H: Negative
47343	1CAEH	-	SyncSignalLogic	2	R/ W	0000H: Positive 0001H: Negative
47344 ~ 47350	1CAFH ~ 1CB5H	~	Reserved	~	~	

Pattern2: Communication address is absolute address of pattern1 +10 , and the data is same as pattern1.

Pattern3: Communication address is absolute address of pattern1 +20 , and the data is same as pattern1.

Pattern4: Communication address is absolute address of pattern1 +30 , and the data is same as pattern1.

Pattern5: Communication address is absolute address of pattern1 +40 , and the data is same as pattern1.

Pattern6: Communication address is absolute address of pattern1 +50 , and the data is same as pattern1.

Pattern7: Communication address is absolute address of pattern1 +60 , and the data is same as pattern1.

Pattern8: Communication address is absolute address of pattern1 +70 , and the data is same as pattern1.

●RS-485 communication setting

47421	1CFCH	-	SlaveAddress	2	R/ W	1~31
47422	1CFDH	-	Baudrate (RS-485)	2	R/ W	0000H: 9600bps, 0001H: 19200bps, 0002H: 38400bps
47423	1CFEH	-	Parity (RS-485)	2	R/ W	0000H: None, 0001H: Even, 0002H: Odd
47424 ~ 47430	1CFFH ~ 1D05H	~	Reserved	~	~	

●RS-232C communication setting

47431	1D06H	-	Baudrate (RS-232C)	2	R/ W	0: 9600bps, 1: 19200bps, 2: 38400bps
47432	1D07H	-	Parity (RS-232C)	2	R/ W	0: None, 1: Even, 2: Odd
47433	1D08H	-	DataLength	2	R/ W	0: 7bit, 1: 8bit •It works only when protocol is "OriginalCommand" or "OriginalOutput".
47434	1D09H	-	Stopbit	2	R/ W	0: 1bit, 1: 2bit •It works only when protocol is "OriginalCommand" or "OriginalOutput".
47435	1D0AH	-	Delimiter	2	R/ W	0: CR, 1: CRLF •It works only when protocol is "OriginalCommand" or "OriginalOutput".
47436	1D0BH	-	Protocol	2	R/ W	0: Modbus-RTU, 1: OriginalCommand, 2: OriginalOutput
47437 ~ 47440	1D0CH ~ 1D0FH	~	Reserved	~	~	

●DispSelect setting

47441	1D10H	-	Ach	2	R/ W	0000H: Disable, 0001H: Enable
47442	1D11H	-	Bch	2	R/ W	0000H: Disable, 0001H: Enable * It works only when measure mode is "Default"
47443	1D12H	-	Calc	2	R/ W	0000H: Disable, 0001H: Enable *1, 2 *1: It works only 2ch product. *2: It works only when measure mode is "Default".
47444	1D13H	-	Ach + Bch	2	R/ W	0000H: Disable, 0001H: Enable * It works only when measure mode is "Default"
47445	1D14H	-	Calc + Ach + Bch	2	R/ W	0000H: Disable, 0001H: Enable *1, 2 *1: It works only 2ch product. *2: It works only when measure mode is "Default".
47446 ~ 47453	1D15H ~ 1D1CH	~	Reserved	~	~	
47454	1D1DH	-	Ach + Comp	2	R/ W	0000H: Disable, 0001H: Enable * It works only when measure mode is "Default"
47455	1D1EH	-	Bch + Comp	2	R/ W	0000H: Disable, 0001H: Enable *1, 2 *1: It works only 2ch product. *2: It works only when measure mode is "Default".
47456	1D1FH	-	Calc + Comp	2	R/ W	0000H: Disable, 0001H: Enable *1, 2 *1: It works only 2ch product. *2: It works only when measure mode is "Default".
47457 ~ 47460	1D20H ~ 1D23H	~	Reserved	~	~	

●LevelSelect setting

47461	1D24H	-	Ach (Level)	2	R/ W	0000H: Disable, 0001H: Enable
47462	1D25H	-	Bch (Level)	2	R/ W	0000H: Disable, 0001H: Enable * It works only when measure mode is "Default"
47463	1D26H	-	Calc (Level)	2	R/ W	0000H: Disable, 0001H: Enable *1, 2 *1: It works only 2ch product. *2: It works only when measure mode is "Default".
47464	1D27H	-	Ach + Bch (Level)	2	R/ W	0000H: Disable, 0001H: Enable * It works only when measure mode is "Default"
47465 ~ 47480	1D28H ~ 1D37H	~	Reserved	~	~	

●TrendSelect setting

47481	1D38H	-	Ach (Trend)	2	R/ W	0000H: Disable, 0001H: Enable
47482	1D39H	-	Bch (Trend)	2	R/ W	0000H: Disable, 0001H: Enable * It works only when measure mode is "Default"
47483	1D3AH	-	Calc (Trend)	2	R/ W	0000H: Disable, 0001H: Enable *1, 2 *1: It works only 2ch product. *2: It works only when measure mode is "Default".
47484	1D3BH	-	Ach + Bch (Trend)	2	R/ W	0000H: Disable, 0001H: Enable * It works only when measure mode is "Default"
47485 ~ 47500	1D3CH ~ 1D4BH	~	Reserved	~	~	

●LevelDisp setting

Pattern1

47501	1D4CH	-	Ach Scale: LowerLimit (LevelDisp)	4	R/ W	±99,999
47503	1D4EH	-	Ach Scale: UpperLimit (LevelDisp)	4	R/ W	±99,999
47505	1D50H	-	Bch Scale: LowerLimit (LevelDisp)	4	R/ W	±99,999
47507	1D52H	-	Bch Scale: UpperLimit (LevelDisp)	4	R/ W	±99,999
47509	1D54H	-	Calc Scale: LowerLimit (LevelDisp)	4	R/ W	±99,999
47511	1D56H	-	Calc Scale: UpperLimit (LevelDisp)	4	R/ W	±99,999
47513 ~ 47531	1D57H ~ 1D69H	~	Reserved	~	~	

Pattern2: Communication address is absolute address of pattern1 +30 , and the data is same as pattern1.

Pattern3: Communication address is absolute address of pattern1 +60 , and the data is same as pattern1.

Pattern4: Communication address is absolute address of pattern1 +90 , and the data is same as pattern1.

Pattern5: Communication address is absolute address of pattern1 +120 , and the data is same as pattern1.

Pattern6: Communication address is absolute address of pattern1 +150 , and the data is same as pattern1.

Pattern7: Communication address is absolute address of pattern1 +180 , and the data is same as pattern1.

Pattern8: Communication address is absolute address of pattern1 +210 , and the data is same as pattern1.

●TrendDisp setting

Pattern1

47741	1E3CH	-	Ach Scale: LowerLimit (TrendDisp)	4	R/ W	±99999
47743	1E3EH	-	Ach Scale: UpperLimit (TrendDisp)	4	R/ W	±99999
47745	1E40H	-	Bch Scale: LowerLimit (TrendDisp)	4	R/ W	±99999
47747	1E42H	-	Bch Scale: UpperLimit (TrendDisp)	4	R/ W	±99999
47749	1E44H	-	Calc Scale: LowerLimit (TrendDisp)	4	R/ W	±99999
47751	1E46H	-	Calc Scale: UpperLimit (TrendDisp)	4	R/ W	±99999
47753 ~ 47764	1E48H ~ 1E53H	~	Reserved	~	~	
47765	1E54H	-	TimeAxis	2	R/ W	0000H: 100msec/div, 0001H: 1s/div, 0002H: 2s/div, 0003H: 5s/div, 0004H: 10s/div, 0005H: 30s/div, 0006H: 60s/div, 0007h: 120s/div
47766 ~ 47770	1E55H ~ 1E59H	~	Reserved	~	~	

Pattern2: Communication address is absolute address of pattern1 +30 , and the data is same as pattern1.

Pattern3: Communication address is absolute address of pattern1 +60 , and the data is same as pattern1.

Pattern4: Communication address is absolute address of pattern1 +90 , and the data is same as pattern1.

Pattern5: Communication address is absolute address of pattern1 +120 , and the data is same as pattern1.

Pattern6: Communication address is absolute address of pattern1 +150 , and the data is same as pattern1.

Pattern7: Communication address is absolute address of pattern1 +180 , and the data is same as pattern1.

Pattern8: Communication address is absolute address of pattern1 +210 , and the data is same as pattern1.

●System setting

47981	1F2CH	-	Brightness	2	R/ W	0000H: 5 Bright, 0001H: 4, 0002H: 3, 0003H: 2, 0004H: 1 Dark, 0005H: Off
47982	1F2DH	-	PowerOnDelay	2	R/ W	0000H: None, 0001H: 2sec, 0002H: 5sec, 0003H: 10sec, 0004H: 20sec, 0005H: 30sec, 0006H: 60sec
47983	1F2EH	-	PowerSavingTime	2	R/ W	0000H: None, 0001H: 1min, 0002H: 2min, 0003H: 5min, 0004H: 10min, 0005H: 30min, 0006H: 60min
47984	1F2FH	~	Reserved	~	~	
47985	1F30H	-	Language	2	R/ W	0000H: Japanese, 0001H: English
47986	1F31H	-	DisplayDirection	2	R/ W	0000H: Horizontal, 0001H: Vertical
47987	1F32H	-	SettingProtect	2	R/ W	0000H: Disable, 0001H: Enable
47988	1F33H	-	D-ZeroRetention	2	R/ W	0000H: Disable, 0001H: Enable
47989	1F34H	-	AdjustProtect	2	R/ W	0000H: Disable, 0001H: Enable 【Only for strain gauge input】
47990	1F35H	-	MeasureMode	2	R/ W	0000H: Default 0001H: Multi 【Only for WPMZ-3】 0002H: WaveCompare 【Only for WPMZ-3】 *Alarm logs and wave logs are initialized.
47991	1F36H		DisplayUpdateCycle	2	R/ W	0000H: 10sps 0001H: 1sps
47992 ~ 48000	1F37H ~ 1F3FH	~	Reserved	~	~	

●Shortcut function setting

48001	1F40H	-	Up key function	2	R/ W	*1 0000H: None, 0001H: Compare Reset 0002H: HoldReset A 0003H: HoldReset B 0004H: HoldReset A&B 0005H: DispHold A *2 0006H: DispHold B *2 0007H: DispHold A&B *2 0008H: MaxHold A *2 0009H: MaxHold B *2 000AH: MaxHold A&B *2 000BH: MinHold A *2 000CH: MinHold B *2 000DH: MinHold A&B *2 000EH: AmpHold A *2 000FH: AmpHold B *2 0010H: AmpHold A&B *2 0011H: DevHold A *2 0012H: DevHold B *2 0013H: DevHold A&B *2 0014H: AveHold A *2 0015H: AveHold B *2 0016H: AveHold A&B *2 0017H: DigitalZero A 0018H: DigitalZero B 0019H: DigitalZero A&B 001AH: DispChange 001BH: TrendLog *2 001CH: PatternChange 1 001DH: PatternChange 2 001EH: PatternChange 3 001FH: MultiHold A *3 0020H: MultiHold B *3 0021H: WaveCompare A *4
-------	-------	---	-----------------	---	---------	---

						0022H: WaveCompare B *4 0023H: ManuAdjust A *5 0024H: ManuAdjust B *5 0025H: AutoAdjust A *5 0026H: AutoAdjust B *5 *1: Commands that are like [xxxB] or [xxxA&B] are settable when 2 input product. *2: It works only when measure mode is "Default". *3: It works only when measure mode is "WaveCompare". *4: It works only when measure mode is "Multi". *5: It works only WPMZ-3. With range check before saving.
48002	1F41H	-	Down key function	2	R/ W	*Please refer to up key function.
48003	1F42H	-	Left key function	2	R/ W	*Please refer to up key function.
48004	1F43H	-	Right key function	2	R/ W	*Please refer to up key function.
48005 ~ 50000	1F44H ~ 270FH	~	Reserved	~	~	

●WaveSelect/ MultiSelect setting

50001	2710H	-	WaveCompare A	2	R/ W	0000H: Disable, 0001H: Enable * It works only when measure mode is "WaveCompare".
50002	2711 H	-	WaveCompare B	2	R/ W	0000H: Disable, 0001H: Enable *1,2 *1: It works only when measure mode is "WaveCompare". *2: It works only 2 input product.
50003	2712 H	-	Multi A Value	2	R/ W	0000H: Disable, 0001H: Enable * It works only when measure mode is "Multi".
50004	2713 H	-	Multi A Graph	2	R/ W	0000H: Disable, 0001H: Enable * It works only when measure mode is "Multi".
50005	2714 H	-	Multi B Value	2	R/ W	0000H: Disable, 0001H: Enable *1,2 *1: It works only when measure mode is "Multi". *2: It works only 2 input product.
50006	2715 H	-	Multi B Graph	2	R/ W	0000H: Disable, 0001H: Enable*1,2 *1: It works only when measure mode is "Multi". *2: It works only 2 input product.
50007 ~ 50050	2716H ~ 2741H	~	Reserved	~	~	

●Hold A setting

Pattern1

50051	2742 H		DispHoldMode	2	R/ W	0: Normal 1: OneShot
50052	2743 H		HoldMode	2	R/ W	0: NormalHold 1: AreaHold
50053	2744 H		DevBaseValue	4	R/ W	±99,999
50055	2746 H		AveHoldCount	2	R/ W	0000H: None, 0001H: 2times, 0002H: 4times, 0003H: 8times, 0004H: 16times, 0005H: 32times, 0006H: 64times
50056 ~ 50080	2747H ~ 275FH	~	Reserved	~	~	

Pattern2: Communication address is absolute address of pattern1 +30 , and the data is same as pattern1.
Pattern3: Communication address is absolute address of pattern1 +60 , and the data is same as pattern1.
Pattern4: Communication address is absolute address of pattern1 +90 , and the data is same as pattern1.
Pattern5: Communication address is absolute address of pattern1 +120 , and the data is same as pattern1.
Pattern6: Communication address is absolute address of pattern1 +150 , and the data is same as pattern1.
Pattern7: Communication address is absolute address of pattern1 +180 , and the data is same as pattern1.
Pattern8: Communication address is absolute address of pattern1 +210 , and the data is same as pattern1.

●Hold B setting

Pattern1: Communication address is absolute address of pattern1 +240, and the data is same as pattern1 of Ach.
Pattern2: Communication address is absolute address of pattern1 +270, and the data is same as pattern1 of Ach.
Pattern3: Communication address is absolute address of pattern1 +300, and the data is same as pattern1 of Ach.
Pattern4: Communication address is absolute address of pattern1 +330, and the data is same as pattern1 of Ach.
Pattern5: Communication address is absolute address of pattern1 +360, and the data is same as pattern1 of Ach.
Pattern6: Communication address is absolute address of pattern1 +390, and the data is same as pattern1 of Ach.
Pattern7: Communication address is absolute address of pattern1 +420, and the data is same as pattern1 of Ach.
Pattern8: Communication address is absolute address of pattern1 +450, and the data is same as pattern1 of Ach.

●Multi A Base setting

Pattern1

50601	2968 H	Ach	SectionSwitch	2	R/ W	0000H: LevelMethod 0001H: EdgeMethod 0002H: EdgeTimer 0003H: AutoTimer
50602	2969 H	Ach	SectionTimerS1	2	R/ W	0~9,999 [×0.01sec]
50603	296A H	Ach	SectionTimerS2	2	R/ W	Same as above
50604	296B H	Ach	SectionTimerS3	2	R/ W	Same as above
50605	296C H	Ach	SectionTimerS4	2	R/ W	Same as above
50606	296D H	Ach	CompleteOutput	2	R/ W	0000H: None 0001H: AL1 0002H: AL2 0003H: AL3 0004H: AL4 * When using the same terminal as the alarm, OR operation is performed.
50607	296E H	Ach	AlarmColorS1	2	R/ W	0000H: Black 0001H: Red 0002H: Yellow 0003H: Green
50608	296F H	Ach	AlarmColorS2	2	R/ W	Same as above
50609	2970 H	Ach	AlarmColorS3	2	R/ W	Same as above
50610	2971 H	Ach	AlarmColorS4	2	R/ W	Same as above
50611	2972 H	Ach	Scale: LowerLimit	4	R/ W	±99,999
50613	2974 H	Ach	Scale: UpperLimit	4	R/ W	±99,999
50615	2976 H	Ach	TimeAxis	2	R/ W	0000H: 100msec/div 0001H: 1s/div 0002H: 2s/div 0003H: 5s/div 0004H: 10s/div 0005H: 30s/div 0006H: 60s/div 0007H: 120s/div
50616 ~ 50630	2977H ~ 2985H	~	Reserved	~	~	

Pattern2: Communication address is absolute address of pattern1 +30 , and the data is same as pattern1.
Pattern3: Communication address is absolute address of pattern1 +60 , and the data is same as pattern1.
Pattern4: Communication address is absolute address of pattern1 +90 , and the data is same as pattern1.

- Pattern5:** Communication address is absolute address of pattern1 +120 , and the data is same as pattern1.
Pattern6: Communication address is absolute address of pattern1 +150 , and the data is same as pattern1.
Pattern7: Communication address is absolute address of pattern1 +180 , and the data is same as pattern1.
Pattern8: Communication address is absolute address of pattern1 +210 , and the data is same as pattern1.

●Multi B Base setting

- Pattern1:** Communication address is absolute address of pattern1 +240, and the data is same as pattern1 of Ach.
Pattern2: Communication address is absolute address of pattern1 +270, and the data is same as pattern1 of Ach.
Pattern3: Communication address is absolute address of pattern1 +300, and the data is same as pattern1 of Ach.
Pattern4: Communication address is absolute address of pattern1 +330, and the data is same as pattern1 of Ach.
Pattern5: Communication address is absolute address of pattern1 +360, and the data is same as pattern1 of Ach.
Pattern6: Communication address is absolute address of pattern1 +390, and the data is same as pattern1 of Ach.
Pattern7: Communication address is absolute address of pattern1 +420, and the data is same as pattern1 of Ach.
Pattern8: Communication address is absolute address of pattern1 +450, and the data is same as pattern1 of Ach.

●Multi A S1 setting

Pattern1

51101	2B5C H	Ach	StartCondition	2	R/ W	0000H: None 0001H: Threshold 0002H: StartDelay
51102	2B5D H	Ach	Threshold	4	R/ W	±99999 [x digit]
51104	2B5F H	Ach	ThresholdDir	2	R/ W	0000H: Excess 0001H: LessThan
51105	2B60 H	Ach	ThresholdTimeout	2	R/ W	0~99.99 [×0.01sec] *It is disable when the value is 0.00.
51106	2B61 H	Ach	TimeoutOutput	2	R/ W	0000H: None 0001H: AL1 0002H: AL2 0003H: AL3 0004H: AL4
51107	2B62 H	Ach	DelayTimer	2	R/ W	0~99.99 [×0.01sec] *It is disable when the value is 0.00.
51108	2B63 H	Ach	HoldType	2	R/ W	0000H: None 0001H: PeakHold 0002H: BottomHold 0003H: AmpHold 0004H: DevHold 0005H: MaxmalHold 0006H: MinimalHold 0007H: DifferenceHold 0008H: InflectionHold
51109	2B64 H	Ach	DevBaseValue	4	R/ W	±99999
51111	2B66 H	Ach	DifValue	4	R/ W	0~99999
51113	2B68 H	Ach	DifMag	2	R/ W	0~9999[x 0.01]
51114	2B69 H	Ach	InfTimeA	2	R/ W	0~499 [point]
51115	2B6A H	Ach	InfTimeB	2	R/ W	0~499 [point]
51116	2B6B H	Ach	InfValueZ	4	R/ W	±99999
51118	2B6D H	Ach	CompOutput	2	R/ W	0000H: None 0001H: AL1 0002H: AL2 0003H: AL3 0004H: AL4
51119	2B6E H	Ach	CompAlarmCond	2	R/ W	0000H: Outside 0001H: Inside
51120	2B6F H	Ach	CompJudgeValue: LowerValue	4	R/ W	±99999
51122	2B71 H	Ach	CompJudgeValue: UpperValue	4	R/ W	±99999
51124	2B73 H	Ach	CompTiming	2	R/ W	0000H: WithInSection 0001H: EndOfSection
51125	2B74 H	Ach	NotDetected	2	R/ W	0000H: NoAlarm 0001H: WithAlarm

●Multi A S4 setting

- Pattern1:** Communication address is absolute address of pattern1 +1920, and the data is same as pattern1 of S1.
- Pattern2:** Communication address is absolute address of pattern1 +1960, and the data is same as pattern1 of S1.
- Pattern3:** Communication address is absolute address of pattern1 +2000, and the data is same as pattern1 of S1.
- Pattern4:** Communication address is absolute address of pattern1 +2040, and the data is same as pattern1 of S1.
- Pattern5:** Communication address is absolute address of pattern1 +2080, and the data is same as pattern1 of S1.
- Pattern6:** Communication address is absolute address of pattern1 +2120, and the data is same as pattern1 of S1.
- Pattern7:** Communication address is absolute address of pattern1 +2160, and the data is same as pattern1 of S1.
- Pattern8:** Communication address is absolute address of pattern1 +2200, and the data is same as pattern1 of S1.

●Multi B S4 setting

- Pattern1:** Communication address is absolute address of pattern1 +2240, and the data is same as pattern1 of S1.
- Pattern2:** Communication address is absolute address of pattern1 +2280, and the data is same as pattern1 of S1.
- Pattern3:** Communication address is absolute address of pattern1 +2320, and the data is same as pattern1 of S1.
- Pattern4:** Communication address is absolute address of pattern1 +2360, and the data is same as pattern1 of S1.
- Pattern5:** Communication address is absolute address of pattern1 +2400, and the data is same as pattern1 of S1.
- Pattern6:** Communication address is absolute address of pattern1 +2440, and the data is same as pattern1 of S1.
- Pattern7:** Communication address is absolute address of pattern1 +2480, and the data is same as pattern1 of S1.
- Pattern8:** Communication address is absolute address of pattern1 +2520, and the data is same as pattern1 of S1.

●WaveCompare A setting

Pattern1

53801	35E8 H	Ach	StartCondition	2	R/ W	0000H: Normal 0001H: Threshold
53802	35E9 H	Ach	Threshold	4	R/ W	±99999 *It is enable only when StartCondition is "Threshold".
53804	35EB H	Ach	ThresholdDir	2	R/ W	0000H: Excess 0001H: LessThan *It is enable only when StartCondition is "Threshold".
53805	35EC H	Ach	ThresholdTimeout	2	R/ W	0~99.99 [×0.01sec] *It is disable when the value is 0.00.
53806	35ED H	Ach	StartPosition	2	R/ W	-100~1000 [sampling]
53807	35EE H	Ach	CompWavePos	2	R/ W	0000H: UpperAndLower 0001H: UpperOnly 0002H: LowerOnly
53808	35EF H	Ach	CreateCompWave: UD Shift	4	R/ W	0~99999
53810	35F1 H	Ach	CreateCompWave: LR Shift	2	R/ W	0~999
53811	35F2 H	Ach	AutoScale	2	R/ W	0000H: Disable 0001H: Enable
53812	35F3 H	Ach	Scale: LowerLimit	4	R/ W	±99999 *It is enable only when AutoScale is "Disable"
53814	35F5 H	Ach	Scale: UpperLimit	4	R/ W	±99999 *It is enable only when AutoScale is "Disable"
53816 ~ 53830	35F7H ~ 3605H	~	Reserved	~	~	

- Pattern2:** Communication address is absolute address of pattern1 +30, and the data is same as pattern1.
- Pattern3:** Communication address is absolute address of pattern1 +60, and the data is same as pattern1.
- Pattern4:** Communication address is absolute address of pattern1 +90, and the data is same as pattern1.
- Pattern5:** Communication address is absolute address of pattern1 +120, and the data is same as pattern1.
- Pattern6:** Communication address is absolute address of pattern1 +150, and the data is same as pattern1.
- Pattern7:** Communication address is absolute address of pattern1 +180, and the data is same as pattern1.
- Pattern8:** Communication address is absolute address of pattern1 +210, and the data is same as pattern1.

●WaveCompare B setting

- Pattern1**: Communication address is absolute address of pattern1 +240, and the data is same as pattern1 of Ach.
Pattern2: Communication address is absolute address of pattern1 +270, and the data is same as pattern1 of Ach.
Pattern3: Communication address is absolute address of pattern1 +300, and the data is same as pattern1 of Ach.
Pattern4: Communication address is absolute address of pattern1 +330, and the data is same as pattern1 of Ach.
Pattern5: Communication address is absolute address of pattern1 +360, and the data is same as pattern1 of Ach.
Pattern6: Communication address is absolute address of pattern1 +390, and the data is same as pattern1 of Ach.
Pattern7: Communication address is absolute address of pattern1 +420, and the data is same as pattern1 of Ach.
Pattern8: Communication address is absolute address of pattern1 +450, and the data is same as pattern1 of Ach.

●Wave data (You can access only the deta of pattern in use.)

54301	37DC H	-	[Non-set value] CH of judgment waveform to be accessed	2	R/W	0000H: Ach 0001H: Bch *You can access this address anytime.
54302	37DD H	-	[Non-set value] Kind of judgment waveform to be accessed	2	R/W	0000H: Measurement data 0001H: UpperJudgementWave 0002H: LowerJudgementWave *You can access this address anytime.
54303 ~ 54310	37DF H ~ 37E5 H	~	Reserved	~	~	
54311	37E6 H	-	1 st point value	4	R	Upper 8bits indicate status. 32 th bit: Display value is disable. 31 th bit: +Over 30 th bit: -Over 29~25 th bit: Non used(0) Lower 24bits are display value. 24~1bit: ±99999 (24bit is MSB and indicates sign)
54313	37E8 H	-	2 nd point value	4	R	Same as above
54315	37EA H	-	3 rd point value	4	R	Same as above
54317 ~ 54603	37EC H ~ 390A H	~	4~147 th point value (Omitted)	~	R	Same as above
54605	390C H	-	148 th value	4	R	Same as above
54607	390E H	-	149 th value	4	R	Same as above
54609	3910 H	-	150 th value	4	R	Same as above
54611 ~ 55000	35F7H ~ 3605H	~	Reserved	~	~	

●Alarm log data

55001	3A98 H	-	Select log No.	2	R/W	Select log No. 0000H: No.1 0001H: No.2 ... 0007H: No.8
55002	3A99 H	-	Select log data	2	R/W	0000H: Ach 0001H: Bch 0002H: Calc
55003	3A9AH	-	Select position	2	R/W	0000H: 0~150 point 0001H: 151~300 point
55004 ~ 55009	3A9B H ~ 3AA0 H	~	Reserved	~	~	
55010	3AA1 H	-	Presence / absence of data of acquisition target log	2	R	0000H: No 0001H: Yes
55011	3AA2 H	-	Time of occurrence of acquisition target log	4	R	0: No data 1~142560: Log data saved 1~142560min ago. 142561: Log data saved over 100 days ago.

55013	3AA4 H	-	Alarm status of acquisition target log	2	R	1 st bit: AL1 alarmed (0: No, 1: Yes) 2 nd bit: AL2 alarmed (0: No, 1: Yes) 3 rd bit: AL3 alarmed (0: No, 1: Yes) 4 th bit: AL4 alarmed(0: No, 1: Yes)
55014	3AA5 H	-	1 st or 151 th value	4	R	Upper 8bits indicate status. 32 th bit: Display value is disable. 31 th bit: +Over 30 th bit: -Over 29~25 th bit: Non used(0) Lower 24bits are display value. 24~1bit: ±99999 (24bit is MSB and indicates sign)
55016	3AA7 H	-	2 nd or 152 th value	4	R	Same as above.
55018	3AA9 H	-	3 rd or 153 th value	4	R	Same as above.
55020 ~ 55307	3AAB H ~ 3BC9 H	~	4 th or 154 th value 147 th or 297 th (Omitted)	~	R	Same as above.
55308	3BCB H	-	148 th or 298 th value	4	R	Same as above.
55310	3BCD H	-	149 th or 299 th value	4	R	Same as above.
55312	3BCF H	-	150 th or 300 th value	4	R	Same as above.
55314 ~ 55500	3BD1H ~ 3C8BH	~	Reserved	~	~	

●Wave log data

55501	3C8C H	-	Select log ch	2	R/ W	0000H: Ach 0001H: Bch
55502	3C8D H	-	Select log type	2	R/ W	0000H: OK log 0001H: NG log
55503	3C8E H	-	Select log No.	2	R/ W	0000H: No.1 0001H: No.2 0002H: No.3 0003H: No.4
55504	3C8F H	-	Select wave type	2	R/ W	0000H: Measurement wave 0001H: Upper judgement wave 0002H: Lower judgement wave
55505 ~ 55509	3C90 H ~ 3C94 H	~	Reserved	~	~	
55510	3C95 H	-	Presence / absence of data of acquisition target log	2	R	0000H: No 0001H: Yes
55511	3C96 H	-	Time of occurrence of acquisition target log	4	R	0: No data 1~142560: Log data saved 1~ 142560min ago. 142561: Log data saved over 100 days ago.
55513	3C98 H	-	Alarm status of acquisition target log	2	R	1 st bit: AL1 alarmed (0: No, 1: Yes) 2 nd bit: AL2 alarmed (0: No, 1: Yes) 3 rd bit: AL3 alarmed (0: No, 1: Yes) 4 th bit: AL4 alarmed(0: No, 1: Yes)
55514	3C99 H	-	1 st point value	4	R	Upper 8bits indicate status. 32 th bit: Display value is disable. 31 th bit: +Over 30 th bit: -Over 29~25 th bit: Non used(0) Lower 24bits are display value. 24~1bit: ±99999 (24bit is MSB and indicates sign)
55516	3C9B H	-	2 nd point value	4	R	Same as above
55518	3C9D H	-	3 rd point value	4	R	Same as above
55520 ~ 55806	3C9F H ~ 3DBD H	~	4~147 th point value (Omitted)	~	R	Same as above
55807	3DBE H	-	148 th value	4	R	Same as above
55809	3DC0 H	-	149 th value	4	R	Same as above
55811	3DC2 H	-	150 th value	4	R	Same as above

Error code

When setting is saved, checking the following range is executed.

If an error exists, the error code is stored in communication address 0 BBAH and the settings are not saved.

The priority order of error codes is ascending order in the table below.

Table 5.4 Error code

Setting	Error judgement	Error code
External input control 1~5 function	Overlapping except [None].	0001H
Compare output AL1 setting Pattern1 •Upper judgement value—Zone judgement •Lower judgement value—Zone judgement	Upper judgement value < Lower judgement value	000AH
AL1 Pattern2	Same as above.	000BH
AL1 Pattern3	Same as above.	000CH
AL1 Pattern4	Same as above.	000DH
AL1 Pattern5	Same as above.	000EH
AL1 Pattern6	Same as above.	000FH
AL1 Pattern7	Same as above.	0010H
AL1 Pattern8	Same as above.	0011H
Compare output AL2 setting Pattern1	Same as above.	0014H
AL2 Pattern2	Same as above.	0015H
AL2 Pattern3	Same as above.	0016H
AL2 Pattern4	Same as above.	0017H
AL2 Pattern5	Same as above.	0018H
AL2 Pattern6	Same as above.	0019H
AL2 Pattern7	Same as above.	001AH
AL2 Pattern8	Same as above.	001BH
Compare output AL3 setting Pattern1	Same as above.	001EH
AL3 Pattern2	Same as above.	001FH
AL3 Pattern3	Same as above.	0020H
AL3 Pattern4	Same as above.	0021H
AL3 Pattern5	Same as above.	0022H
AL3 Pattern6	Same as above.	0023H
AL3 Pattern7	Same as above.	0024H
AL3 Pattern8	Same as above.	0025H
Compare output AL4 setting Pattern1	Same as above.	0028H
AL4 Pattern2	Same as above.	0029H
AL4 Pattern3	Same as above.	002AH
AL4 Pattern4	Same as above.	002BH
AL4 Pattern5	Same as above.	002CH
AL4 Pattern6	Same as above.	002DH
AL4 Pattern7	Same as above.	002EH
AL4 Pattern8	Same as above.	002FH
LevelDisp setting Pattern1 •Ach Scale: LowerLimit •Ach Scale: UpperLimit	LowerLimit ≥ UpperLimit	003CH
Pattern2	Same as above.	003DH
Pattern3	Same as above.	003EH
Pattern4	Same as above.	003FH
Pattern5	Same as above.	0040H
Pattern6	Same as above.	0041H
Pattern7	Same as above.	0042H
Pattern8	Same as above.	0043H
LevelDisp setting Pattern1 •Bch Scale: LowerLimit •Bch Scale: UpperLimit	Same as above.	0046H
Pattern2	Same as above.	0047H
Pattern3	Same as above.	0048H
Pattern4	Same as above.	0049H
Pattern5	Same as above.	004AH
Pattern6	Same as above.	004BH
Pattern7	Same as above.	004CH
Pattern8	Same as above.	004DH
LevelDisp setting Pattern1 •Calc Scale: LowerLimit •Calc Scale: UpperLimit	Same as above.	0050H

Pattern2	Same as above.	0051H
Pattern3	Same as above.	0052H
Pattern4	Same as above.	0053H
Pattern5	Same as above.	0054H
Pattern6	Same as above.	0055H
Pattern7	Same as above.	0056H
Pattern8	Same as above.	0057H
TrendDisp setting Pattern1 •Ach Scale: LowerLimit •Ach Scale: UpperLimit	LowerLimit\geqUpperLimit	0078H
Pattern2	Same as above.	0079H
Pattern3	Same as above.	007AH
Pattern4	Same as above.	007BH
Pattern5	Same as above.	007CH
Pattern6	Same as above.	007DH
Pattern7	Same as above.	007EH
Pattern8	Same as above.	007FH
TrendDisp setting Pattern1 •Bch Scale: LowerLimit •Bch Scale: UpperLimit	Same as above.	0082H
Pattern2	Same as above.	0083H
Pattern3	Same as above.	0084H
Pattern4	Same as above.	0085H
Pattern5	Same as above.	0086H
Pattern6	Same as above.	0087H
Pattern7	Same as above.	0088H
Pattern8	Same as above.	0089H
TrendDisp setting Pattern1 •Calc Scale: LowerLimit •Calc Scale: UpperLimit	Same as above.	008CH
Pattern2	Same as above.	008DH
Pattern3	Same as above.	008EH
Pattern4	Same as above.	008FH
Pattern5	Same as above.	0090H
Pattern6	Same as above.	0091H
Pattern7	Same as above.	0092H
Pattern8	Same as above.	0093H
•DispSelect •LevelSelect •TrendSelect	All displays are disable	00C8H
Ach input setting Pattern1 LinearizePoint	It is considered to be an error if it is not 1st input < 2nd input < ...20th input < 21th input. However, if the input value and the output value are both 0 at the second and subsequent points, it is considered to be terminated, so it is not checked after that.	00D2H
Pattern2	Same as above.	00D3H
Pattern3	Same as above.	00D4H
Pattern4	Same as above.	00D5H
Pattern5	Same as above.	00D6H
Pattern6	Same as above.	00D7H
Pattern7	Same as above.	00D8H
Pattern8	Same as above.	00D9H
Bch input setting Pattern1 LinearizePoint	Same as above.	00DCH
Pattern2	Same as above.	00DDH
Pattern3	Same as above.	00DEH
Pattern4	Same as above.	00DFH
Pattern5	Same as above.	00E0H
Pattern6	Same as above.	00E1H
Pattern7	Same as above.	00E2H
Pattern8	Same as above.	00E3H
WaveCompare A settings Pattern1 •Scale: LowerLimit •Scale: UpperLimit	LowerLimit\geqUpperLimit	00E6H
Pattern2	Same as above.	00E7H
Pattern3	Same as above.	00E8H
Pattern4	Same as above.	00E9H
Pattern5	Same as above.	00EAH
Pattern6	Same as above.	00EBH

Pattern7	Same as above.	00ECH
Pattern8	Same as above.	00EDH
WaveCompare B settings Pattern1 •Scale: LowerLimit •Scale: UpperLimit	Same as above.	00F0H
Pattern2	Same as above.	00F1H
Pattern3	Same as above.	00F2H
Pattern4	Same as above.	00F3H
Pattern5	Same as above.	00F4H
Pattern6	Same as above.	00F5H
Pattern7	Same as above.	00F6H
Pattern8	Same as above.	00F7H
Multi A Base setting Pattern1 •Scale: LowerLimit •Scale: UpperLimit	Same as above.	00FAH
Pattern2	Same as above.	00FBH
Pattern3	Same as above.	00FCH
Pattern4	Same as above.	00FDH
Pattern5	Same as above.	00FEH
Pattern6	Same as above.	00FFH
Pattern7	Same as above.	0100H
Pattern8	Same as above.	0101H
Multi B Base setting Pattern1 •Scale: LowerLimit •Scale: UpperLimit	Same as above.	0104H
Pattern2	Same as above.	0105H
Pattern3	Same as above.	0106H
Pattern4	Same as above.	0107H
Pattern5	Same as above.	0108H
Pattern6	Same as above.	0109H
Pattern7	Same as above.	010AH
Pattern8	Same as above.	010BH

5-1-2. Measurement data

1. Input register

The input register command is as shown in the table below.

The input register is read only and can not be written.

Table 5.5 Input register command

Read command	04H
Write command	-
Continuous write command	-

Measurement data

Measurement data are shown below.

To obtain measurement data, refer to [\[4-1-1. Acquire measurement data\]](#).

Table 5.6 Measurement data

Absolute address (Decimal number)	Communication address (Hexadecimal)	CH	Contents	Size (byte)	R/W	The data
30000	0000H	-	Operation mode	2	R	0000H: Awake display, 0001H: Measurement display, 0002H: Setting display
30001	0001H	-	Error status	2	R	0000H: No error, Except 0000H: Some errors
30002 ~ 30101	0002H ~ 0064H	~	Reserved	~	~	
30102	0065H	-	External control input status	2	R	0001H: Terminal 1ON, 0002H: Terminal 2ON, 0004H: Terminal 3ON, 0008H: Terminal 4ON, 0010H: Terminal 5ON

30103	0066H	-	Pattern number in use	2	R	0000H:Pattern1, 0001H:Pattern2, 0002H:Pattern3, 0003H:Pattern4, 0004H:Pattern5, 0005H:Pattern6, 0006H:Pattern7, 0007H:Pattern8
30104 ~ 30200	0067H ~ 018FH	~	Reserved	~	~	
30201	00C8H	Ach	Display value status (Ach)	4	R	1bit: Display value is disable 2bit: +Over 3bit: -Over 4bit: Reserved (R: 0, W: Disable) 5bit: DigitalZero 6bit: TrackingZero 7bit: Stable 8bit: NearZero 9~16bit: Reserved (R: 0, W: Disable) 17bit: HoldReset 18bit: Holding is not detected 19bit: DispHold 20bit: PeakHold 21bit: BottomHold 22bit: AmpHold 23bit: DevHold 24bit: AveHold 25bit: MaximamHold 26bit: MinimalHold 27bit: DifferenceHold 28bit: InflareHold 29-32bit: Reserved (R: 0, W: Disable) *0: Non active 1: Active
30203	00CA H	Ach	Display value (Ach)	4	R	±99999 (Integer without decimal point)
30205	00CC H	Ach	Dec point (Ach)	2	R	0000H:##### 0001H:##### 0002H:###.### 0003H:##.### 0004H:#.#####
30206 ~ 30250	00CDH ~ 00D0H	~	Reserved	~	~	
30251	00FAH	Ach	Input value status (Ach)	2	R	1bit: Display value is disable 2bit: +Over 3bit: -Over *0: Non active 1: Active
30252	00FBH	Ach	Real quantity value of measured value (Ach)	4	R	Directly read input voltage or current. (Integer without decimal point) 【Input A: Process】 ±5V: ±50000 0-5V: 0~50000 1-5V: 10000~50000 ±10V: ±10000 0-10V: 0~10000 ±20mA: ±20000 0-20mA: 0~20000 4-20mA: 4000~20000 【Input A: Straingauge】 ±3.5mV/V: ±35000 【InputA: DC】 ±99.999mV: ±109999 [x0.001mV] ±999.99mV: ±109999 [x0.01mV] ±9.9999V: ±109999 [x0.1mV] ±99.999uA: ±109999 [x0.001uA] ±999.99uA: ±109999 [x0.01uA] ±9.9999mA: ±109999 [x0.1uA]
30254	00FDH	Ach	% Value of measured value (Ach)	4	R	Both ends of the range shall be 0 to 100%. ex) ±5V: -5~5V is 0~100% 1~5V: 1~5V is 0~100%
30256 ~ 30300	00FFH ~ 012BH	~	Reserved	~	~	

30301	012CH	Bch	Display value status (Bch)	4	R	Same as Ach.
30303	012E H	Bch	Display value (Bch)	4	R	Same as Ach.
30305	0130 H	Bch	Dec point (Bch)	2	R	Same as Ach.
30306 ~ 30350	0131H ~ 015DH	~	Reserved	~	~	
30351	015EH	Bch	Input value status (Bch)	2	R	Same as Ach.
30352	015FH	Bch	Real quantity value of measured value (Bch)	4	R	Same as Ach.
30354	0161H	Bch	% Value of measured value (Bch)	4	R	Same as Ach.
30356 ~ 30600	0163H ~ 0257H	~	Reserved	~	~	
30601	0258H	-	Display value status (Calc)	2	R	1bit: Display value is disable 2bit: +Over 3bit: -Over *0: Non active 1: Active
30602	0259H	-	Display value (Calc)	4	R	±99999 (Integer without decimal point)
30604	025BH	-	Dec point (Calc)	2	R	0000H:##### 0001H:##### 0002H:###.### 0003H:##.### 0004H:#.#####
30605 ~ 30700	025CH ~ 02BBH	~	Reserved	~	~	
30701	02BC	Ach	WaveCompare A status	2	R	0000H= READY 0001H= WAIT 0002H= RUN 0003H= END
30702	02BD	Ach	WaveCompare A result	2	R	0000H= Uncertain 0001H= OK 0002H= NG
30703 ~ 30750	02BEH ~ 02EDH	~	Reserved	~	~	
30751	02EEH	Bch	WaveCompare B status	2	R	Same as Ach.
30752	02EFH	Bch	WaveCompare B result	2	R	Same as Ach.
30753 ~ 30800	02F0H ~ 031FH	~	Reserved	~	~	
30801	0320H	Ach	MultiHold A status	2	R	0000H: READY 0001H: Section 1 WAIT 0002H: Section 1 RUN 0003H: Section 1 END 0004H: Section 2 WAIT 0005H: Section 2 RUN 0006H: Section 2 END 0007H: Section 3 WAIT 0008H: Section 3 RUN 0009H: Section 3 END 000AH: Section 4 WAIT 000BH: Section 4 RUN 000CH: Section 4 (This state is not occurred and skipped.) 000DH: Result
30802	0321H	Ach	MultiHold A result	2	R	0000H: Uncertain 0001H: OK 0002H: NG
30803	0322 H	Ach	Section 1 result	2	R	0000H:Uncertain 0001H:Finished correctly 0002H:Alarm occurred
30804	0323 H	Ach	Section 2 result	2	R	Same as Section 1.
30805	0324 H	Ach	Section 3 result	2	R	Same as Section 1.
30806	0325 H	Ach	Section 4 result	2	R	Same as Section 1.
30807	0326 H	Ach	Display value status of section 1	4	R	1bit: Display value is disable 2bit: +Over 3bit: -Over 4bit: Reserved (R: 0, W: Disable)

						5bit: DigitalZero 6bit: TrackingZero 7bit: Stable 8bit: NearZero 9~16bit: Reserved (R: 0, W: Disable) 17bit: HoldReset 18bit: Holding is not detected 19bit: DispHold 20bit: PeakHold 21bit: BottomHold 22bit: AmpHold 23bit: DevHold 24bit: AveHold 25bit: MaximamHold 26bit: MinimalHold 27bit: DifferenceHold 28bit: InflareHold 29-32bit: Reserved (R: 0, W: Disable) *0: Non active 1: Active
30809	0328 H	Ach	Display value of section 1	4	R	±99999 (Integer without decimal point)
30811	032A H	Ach	DecPoint of section 1	2	R	0000H:##### 0001H:##### 0002H:###.### 0003H:##.### 0004H:#.#####
30812	032B H	Ach	Display value status of section 2	4	R	Same as Section 1.
30814	032D H	Ach	Display value of section 2	4	R	Same as Section 1.
30816	032F H	Ach	DecPoint of section 2	2	R	Same as Section 1.
30817	0330 H	Ach	Display value status of section 3	4	R	Same as Section 1.
30819	0332 H	Ach	Display value of section 3	4	R	Same as Section 1.
30821	0334 H	Ach	DecPoint of section 3	2	R	Same as Section 1.
30822	0335 H	Ach	Display value status of section 4	4	R	Same as Section 1.
30824	0337 H	Ach	Display value of section 4	4	R	Same as Section 1.
30826	0339 H	Ach	DecPoint of section 4	2	R	Same as Section 1.
30827 ~ 30850	033AH ~ 0351H	~	Reserved	~	~	
30851	0352 H	Bch	MultiHold B status	2	R	Same as Ach.
30852	0353 H	Bch	MultiHold B result	2	R	Same as Ach.
30853	0354 H	Bch	Section 1 result	2	R	Same as Section 1 of Ach.
30854	0355 H	Bch	Section 2 result	2	R	Same as Section 1 of Ach.
30855	0356 H	Bch	Section 3 result	2	R	Same as Section 1 of Ach.
30856	0357 H	Bch	Section 4 result	2	R	Same as Section 1 of Ach.
30857	0358 H	Bch	Display value status of section 1	4	R	Same as Section 1 of Ach.
30859	035A H	Bch	Display value of section 1	4	R	Same as Section 1 of Ach.
30861	035C H	Bch	DecPoint of section 1	2	R	Same as Section 1 of Ach.
30862	035D H	Bch	Display value status of section 2	4	R	Same as Section 1 of Ach.
30864	035F H	Bch	Display value of section 2	4	R	Same as Section 1 of Ach.
30866	0361 H	Bch	DecPoint of section 2	2	R	Same as Section 1 of Ach.
30867	0362 H	Bch	Display value status of section 3	4	R	Same as Section 1 of Ach.
30869	0364 H	Bch	Display value of section 3	4	R	Same as Section 1 of Ach.
30871	0366 H	Bch	DecPoint of section 3	2	R	Same as Section 1 of Ach.
30872	0367 H	Bch	Display value status of section 4	4	R	Same as Section 1 of Ach.
30874	0369 H	Bch	Display value of section 4	4	R	Same as Section 1 of Ach.
30876	036B H	Bch	DecPoint of section 4	2	R	Same as Section 1 of Ach.
30877 ~ 31000	036CH ~ 03E7H	~	Reserved	~	~	
31001	03E8H	AL1	Compare output status AL1	2	R	0001H: Compare output reset ON, 0002H: Latch ON
31002	03E9H	AL1	Compare output AL1	2	R	0000H: OFF, 0001H: ON
31003 ~ 31050	03EAH ~ 0419H	~	Reserved	~	~	
31051	041AH	AL2	Compare output status AL2	2	R	*Please refer to AL1.
31052	041BH	AL2	Compare output AL2	2	R	*Please refer to AL1.
31053 ~ 31100	041CH ~ 044BH	~	Reserved	~	~	
31101	044CH	AL3	Compare output status AL3	2	R	*Please refer to AL1.

31102	044DH	AL3	Compare output AL3	2	R	*Please refer to AL1.
31103 ~ 31150	044EH ~ 047DH	~	Reserved	~	~	
31151	047EH	AL4	Compare output status AL4	2	R	*Please refer to AL1.
31152	047FH	AL4	Compare output AL4	2	R	*Please refer to AL1.
31153 ~ 31160	047FH ~ 0487H	~	Reserved	~	~	
31161	0488H	Ach	Compare output status Ach Go output	2	R	0001H: Compare output reset ON, 0002H: Latch ON
31162	0489H	Ach	Compare output Ach Go output	2	R	0000H: OFF, 0001H: ON
31163 ~ 31170	048AH ~ 0491H	~	Reserved	~	~	
31171	0492H	Bch	Compare output status Bch Go output	2	R	0001H: Compare output reset ON, 0002H: Latch ON
31172	0493H	Bch	Compare output Bch Go output	2	R	0000H: OFF, 0001H: ON

Common property

Common properties are shown below.

Table 5.7 Common property

Absolute address (Decimal number)	Communication address (Hexadecimal)	CH	Contents	Size (byte)	R/W	The data
39001	2328H	-	Module status	8	R	Except 0: error
39005	232CH	-	Vendor name	16	R	ASCII string “Watanabe Electric Industry” fixation ※2 characters per register
39021	233CH	-	Product type	16	R	ASCII string ※2 characters per register
39037	234CH	-	Firmware version	4	R	ASCII string ※2 characters per register
39041	2350H	-	Hardware version	4	R	ASCII string ※2 characters per register
39045	2354H	-	Modbus table version	4	R	ASCII string ※2 characters per register
39049	2358H	-	Product number	16	R	ASCII string ※2 characters per register

6. Troubleshooting

6-1. About communication

6-1-1. Communication abnormal

If the communication isn't possible, please check the following items.

- Are all the devices related to communication turned on?
- Is the wiring correct?
- Are the number of connected devices and the connection distance are appropriate?
- Do communication condition settings match between Master and Slave (Module)?
(baud rate, data length, stop bit, parity)
- Dose the timing of transmit and receive signals satisfy "3-2. Transmission Switching Time"?
- Dose the slave ID specified as the transmission destination from the master match the slave ID setting of the connected slave (module)?
- Is the same slave ID set for the modules connected on the same transmission line?
- Is a terminal resistance attached on the transmission line?

6-1-2. The acquired data is abnormal

If data can be acquired but value is wrong, please check the following items.

- Is the function code correct?
- Is the address the address of the data to be obtained?
- Is conversion carried out?

The contents of this instruction manual are subject to change without prior notice.

watanabe

WATANABE ELECTRIC INDUSTRY CO.,LTD.

<http://www.watanabe-electric.co.jp/en/>

Central Office 6-16-19,JINGUMAE,SHIBUYA-KU,TOKYO 150-0001,JAPAN
TEL +81-3-3400-6147 FAX +81-3-3409-3156

February ,2019 IM-0887-01