

MODEL A5000 SERIES INSTRUCTION MANUAL



Caution

- (1) Do not apply a voltage or current exceeding the maximum allowable value; otherwise, it may damage the equipment.
- (2) Use a power voltage within the operation range; otherwise, it may result in a fire, electrical shock, or malfunction.
- (3) The contents of this manual are subject to change without notice.
- (4) Although the contents of this manual have been prepared with extra care, if you have any questions, or find errors or missing information, contact the sales agent from which you purchased the product or Watanabe Electric Industry Co.,Ltd.
- (5) After reading this manual thoroughly, keep it in a convenient place for future reference.
- (6) The mark on a label shows the measurement tail range of the input specification of 8.1. clause.

1. Before Using the Product

Thank you for purchasing the A5000 series. This manual should be passed on to the person who operates the product. Examine the product for damage caused by transportation or any other defects. If you find any damage or defects, contact the sales agent from which you purchased the product or Watanabe Electric Industry Co., Ltd.

1.1. Model Codes

The model lineup of the A5000 series is shown below. Check that the model code and specifications of your product match those you specified when ordering.

A 5 X X X - X X

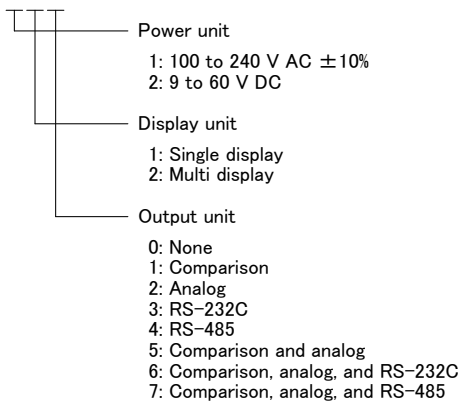

A 5 X X X - X X

Input unit

- 01: DC voltage measuring unit (range 11: ± 99.99 mV)
- 02: DC voltage measuring unit (range 12: ± 999.9 mV ; range 13: ± 9.999 V) (range 14: ± 99.99 V ; range 15: ± 600 V)
- 03: DC current measuring unit (range 23: ± 9.999 mA; range 24: ± 99.99 mA) (range 25: ± 999.9 mA)
- 04: AC voltage measuring unit (average rms) (range 11: 99.99 mV; range 12: 999.9 mV) (range 13: 9.999 V)
- 05: AC voltage measuring unit (average rms) (range 14: 99.99 V; range 15: 600 V)
- 06: AC voltage measuring unit (true rms) (range 11: 99.99 mV; range 12: 999.9 mV) (range 13: 9.999 V)
- 07: AC voltage measuring unit (true rms) (range 14: 99.99 V; range 15: 600 V)
- 08: AC current measuring unit (average rms) (range 23: 9.999 mA; range 24: 99.99 mA) (range 25: 999.9 mA)
- 09: AC current measuring unit (average rms) (range 26: 5 A)
- 10: AC current measuring unit (true rms) (range 23: 9.999 mA; range 24: 99.99 mA) (range 25: 999.9 mA)
- 11: AC current measuring unit (true rms) (range 26: 5 A)
- 12: Resistance measuring unit
- 13: Temperature measuring unit (TC)
- 14: Temperature measuring unit (RTD)
- 15: Frequency measuring unit (inputs: open collector, logic, and magnet)
- 16: Frequency measuring unit(input: 50 to 500 Vrms)
- 17: Strain gauge input unit (load cell)
- 18: Process signal measuring unit (4 to 20 mA or 1 to 5 V)

2. Mounting the Product

2.1. Dimensions for Cutting Panel

Cut the panel for mounting according to the following dimensions.

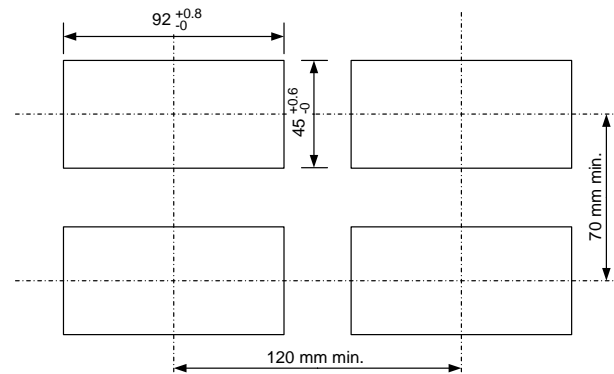

2.2. Mounting the Product to the Panel

To mount the A5000 to the panel, remove its fittings and insert it through the hole in the front of the panel. From the back of the panel, fix the product to the panel with the fittings.

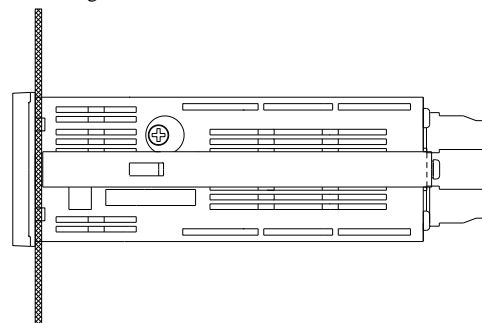

Caution

- (1) Mount the product to a panel that is strong enough to hold the product. If the panel is not strong enough or the product is not fixed tightly, it may fall down and cause injury.
- (2) The A5000 does not have a power switch, and will thus be immediately ready for operation upon connecting it to a power supply.
- (3) If the product is installed inside other equipment, provide sufficient heat dissipation to ensure that the temperature inside the equipment does not exceed 50°C.

3. Terminal Arrangement

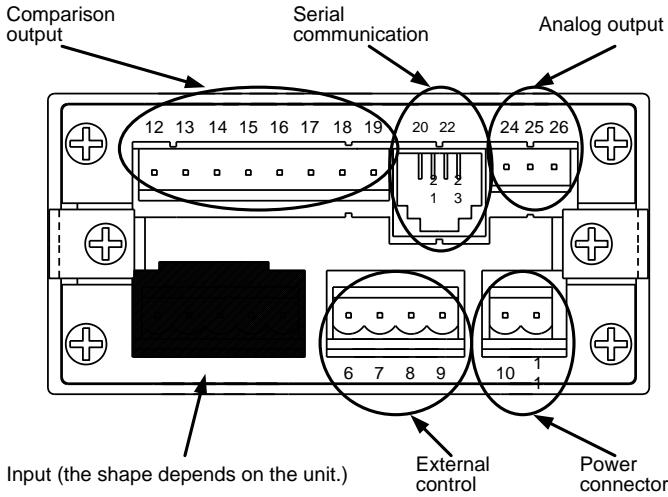

3.1. Power



No.	Name	Description
10	POWER	Power terminal without polarity for both DC and AC
11	POWER	Power terminal without polarity for both DC and AC

3.2. External Controls

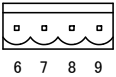

No.	Name	Description
6	HOLD	Control for hold function. Enabled when short-circuited or at the same potential as COM.
7	DZ	Control for digital zero function. Enabled when short-circuited or at the same potential as COM.
8	PH	Control for peak hold function. Enabled when short-circuited or at the same potential as COM.
9	COM	Common for all external control terminals.

3.3. Input Signals

3.3.1 DC Voltage Measuring Unit (Range 11)

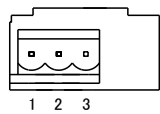

No.	Name	Description
1	HI	Positive input terminal
2	NC	Do not connect this terminal.
3	LO	Negative input terminal

3.3.2 DC Voltage Measuring Unit (Range 12)

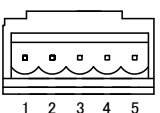

No.	Name	Description
1	12	Positive input terminal for range 12 (± 999.9 mV)
2	13	Positive input terminal for range 13 (± 9.999 V)
3	14	Positive input terminal for range 14 (± 99.99 V)
4	15	Positive input terminal for range 15 (± 600 V)
5	LO	Negative input terminal

3.3.3. DC Current Measuring Unit

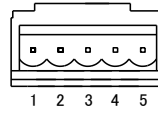

No.	Name	Description
1	23	Positive input terminal for range 23 (± 9.999 mA)
2	24	Positive input terminal for range 24 (± 99.99 mA)
3	25	Positive input terminal for range 25 (± 999.9 mA)
4	LO	Negative input terminal
5		

3.3.4. AC Voltage Measuring Unit (Ranges 11 to 13)

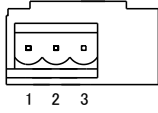

No.	Name	Description
1	11-12	Positive input terminal for ranges 11 (99.99 mV) and 12 (999.9 mV)
2	13	Positive input terminal for range 13 (9.999 V)
3	LO	Common input terminal

3.3.5. AC Voltage Measuring Unit (Ranges 14 and 15)

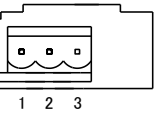

No.	Name	Description
1	14	Positive input terminal for range 14 (99.99 V)
2	15	Positive input terminal for range 15 (600 V)
3	LO	Common input terminal

3.3.6. AC Current Measuring Unit (Ranges 23 to 25)

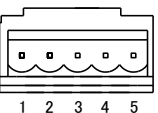

No.	Name	Description
1	23	Positive input terminal for range 23 (9.999 mA)
2	24	Positive input terminal for range 24 (99.99 mA)
3	25	Positive input terminal for range 25 (999.9 mA)
4	LO	Negative input terminal
5		

3.3.7. AC Current Measuring Unit (Range 26)

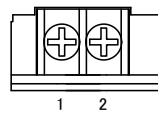

No.	Name	Description
1	HI	Input terminal
2	LO	Input terminal

Applicable solderless terminals

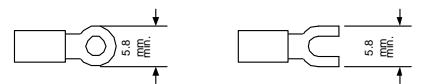

3.3.8. Resistance Measuring Unit

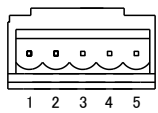

No.	Name	Description
1	HI	Input terminal for all ranges
2	LO	Input terminal for all ranges
3	+S	Constant current for four-wire resistance measurement (positive)
4	-S	Constant current for four-wire resistance measurement (negative)
5	COM	Common terminal (grounding terminal for input circuit)

※Set to the 4-wire system when shipped. When changing to the 2-wire system, locate the ST1 socket on the resistance measurement unit to the "2" positions.

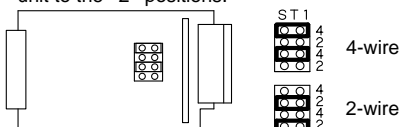

3.3.9. Temperature Measuring Unit (TC)

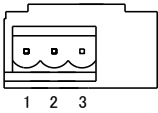

No.	Name	Description
1	+	Positive terminal for thermocouple
2	NC	Do not connect this terminal.
3	-	Negative terminal for thermocouple

3.3.10. Temperature Measuring Unit (RTD)

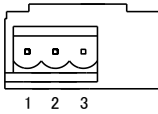

No.	Name	Description
1	A	Resistance sensor wire
2	B	Resistance sensor wire
3	C	Elimination of wire resistance

When A or B is disconnection, it is displayed as OL, and when C is disconnection, it is displayed as ----.

The analog output at the time of a burnout becomes + side at the time of A or B disconnection, and is set to 0V or 1V, and 4mA at the time of C disconnection.

Connection of three-wire sensor

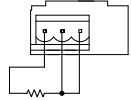

3.3.11. Frequency Measuring Unit (Open collector, logic, and magnet)

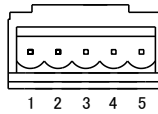

No.	Name	Description
1	HI	Positive input terminal
2	LO	Negative input terminal
3	+15V	Power output for sensor (positive)
4	0V	Power output for sensor (negative)
5	COM	Common terminal (grounding terminal for input circuit)

3.3.12. Frequency Measuring Unit (500 Vrms)

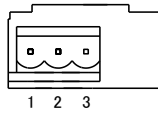

No.	Name	Description
1	HI	Input terminal
2	NC	Do not connect this terminal.
3	LO	Input terminal

3.3.13. Strain Gauge Input Unit (Load cell)

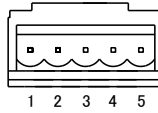

No.	Name	Description
1	+SIG	Positive input terminal
2	-SIG	Negative input terminal
3	+EXC	Power output for sensor (positive)
4	-EXC	Power output for sensor (negative)
5	COM	Common terminal (grounding terminal for input circuit)

3.3.14. Process Signal Measuring Unit

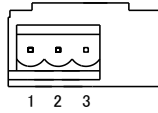

No.	Name	Description
1	V-IN	Positive input terminal for 1 to 5 V range
2	A-IN	Positive input terminal for 4 to 20 mA range
3	LO	Negative input terminal

3.4. Comparison Output

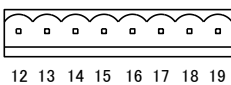

No.	Name	Description
12	LO-b	LO output terminal (b contact)
13	LO-c	Common terminal for LO output
14	LO-a	LO output terminal (a contact)
15	GO-c	Common terminal for GO output
16	GO-a	GO output terminal (a contact)
17	HI-b	HI output terminal (b contact)
18	HI-c	Common terminal for HI output
19	HI-a	HI output terminal (a contact)

3.5. Analog Output



No.	Name	Description
24	COM	Common terminal for analog output
25	A-OUT	Current output terminal (4 to 20 mA)
26	V-OUT	Voltage output terminal (1 to 5 V, 0 to 1 V, and 0 to 10 V)

3.6. Serial Communication

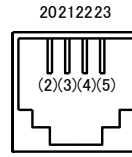

Modular jack: RJ-14(6P 4C)

No.	Name	Description
20	RXD(+)	RS-232C: transmission; RS-485: Non-reverse output
21	TXD(-)	RS-232C: reception; RS-485: Reverse output
22	NC	Do not connect this terminal.
23	SG	Common terminal for communications

Caution

- Use 12 to 28 AWG wire for the power, input (except for range 26), external control, and comparison output connectors.
- Tighten the screws for the power, input (except for range 26), external control, and comparison output connectors to a torque of 0.5 to 0.6 Nm.
- Use 16 to 28 AWG wire for the analog output connector.
- Tighten the screws of analog output connector to a torque of 0.22 to 0.25 Nm.
- Each wiring except a power supply is given as under full-length 30m. If 30m is exceeded, it will become out of the scope of EN/IEC standard.

4. Components and their Functions

The front panel design of the A5000 series of unit meters differs depending on the display unit selected. The names and functions of each unit are as shown below.

4.1. Multi-display Unit

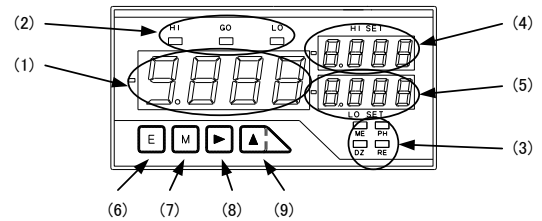

No.	Name	Main Functions	
		During measurement	During parameter setup
(1)	Main display	Indicates the measured value.	Indicates information on the parameter to be set.
(2)	Judgment indicators	HI	Indicates the result of judgment and turns on if the measured value > HI judgment value.
		GO	Indicates the result of judgment and turns on if LO judgment value ≤ the measured value ≤ HI judgment value.
		LO	Indicates the result of judgment and turns on if the measured value < LO judgment value.
(3)	Function indicators	ME	Turns on if "digital zero backup" is on.
		PH	Turns on if "peak hold/valley hold/peak - valley hold" is on.
		DZ	Turns on if "digital zero" is on.
		RE	Turns on if remote control is being performed through RS-232C or RS-485 interface.
(4)	Sub-display 1	Indicates the HI side judgment value.	Indicates the item in the maximum/minimum/(maximum-minimum)/input value monitoring mode.
(5)	Sub-display 2	Indicates the LO side judgment value.	Indicates the item to be set.
(6)	Enter key	Pressing the Enter and Mode keys together changes to the parameter setting mode.	Returns to the measurement mode.
		Pressing the Enter and Increment keys together changes to the maximum/minimum/(maximum-minimum)/input value monitoring mode.	
		Switches from the maximum/minimum/(maximum-maximum/minimum/(maximum-minimum)/input value monitoring mode to the comparative judgment reading mode.	

(7)	Mode key	Pressing the Mode and Enter keys together changes to the parameter setting mode.	Selects the item to be set.
		Pressing the Mode and Shift keys together changes to the shift function setup mode.	
		Pressing the Mode and Incremental keys together turns on/off the "Digital zero" indicator.	
(8)	Shift key	Pressing the Shift and Mode keys together changes to the shift function setup mode.	
		Selects from items in the maximum/minimum/(maximum-minimum)/input value monitoring mode. (Hold down the key for about one second.)	
(9)	Increment key	Pressing the Increment and Mode keys together turns on/off the "Digital zero" indicator.	Changes the value or content of a selected digit. (Increments the value)
		Pressing the Increment and Enter keys changes to the maximum/minimum/(maximum-minimum)/input value monitoring mode.	
		Resets the maximum/minimum/(maximum-minimum)/input value monitoring mode. (Hold down the key for about one second)	

(8)	Shift key	Pressing the Shift and Mode keys together changes to the shift function setup mode.	
		Holding down the Shift key for about one second moves to the HI judgment value indicator.	
(9)	Increment key	Selects from items in the maximum/minimum/(maximum-minimum)/input value monitoring mode. (Hold down the key for about one second.)	
		Pressing the Increment and Mode keys together turns on/off the "Digital zero" indicator.	Changes the value or content of a selected digit. (Increments the value)
		Holding down the Increment key for about one second moves to the LO judgment value indicator.	
(9)	Increment key	Pressing the Increment and Enter keys changes to the maximum/minimum/(maximum-minimum)/input value monitoring mode.	
		Resets the maximum/minimum/(maximum-minimum)/input value monitoring mode. (Hold down the key for about one second.)	

4.2. Single Display Unit

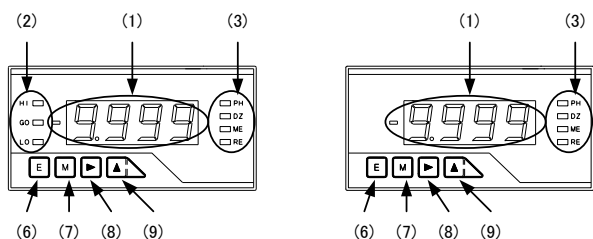

No.	Name	Main Functions	
		During measurement	During parameter setup
(1)	Main display	Indicates the measured value.	Indicates information on the parameter to be set.
(2)	Judgment indicators	HI Indicates the result of judgment and turns on if the measured value > HI judgment value.	
		GO Indicates the result of judgment and turns on if LO judgment value ≤ the measured value ≤ HI judgment value.	
		LO Indicates the result of judgment and turns on if the measured value < LO judgment value.	
(3)	Function indicators	PH Turns on if "peak hold/valley hold/peak - valley hold" is on.	
		DZ Turns on if "digital zero" is on.	
		ME Flashes when linearization data output values are set.	
		RE Turns on if "digital zero backup" is on.	
(6)	Enter key	Pressing the Mode and Enter keys together changes to the parameter setting mode.	Returns to the measurement mode.
		Pressing the Enter and Increment keys together changes to the maximum/minimum/(maximum-minimum)/input value monitoring mode.	
		Switches from the maximum/minimum/(maximum-minimum)/input value monitoring mode to the comparative judgment reading mode.	
(7)	Mode key	Pressing the Mode and Enter keys together changes to the parameter setting mode.	Selects the item to be set.
		Pressing the Mode and Shift keys together changes to the shift function setup mode.	
		Pressing the Mode and Incremental keys together turns on/off the "Digital zero" indicator.	

5. Parameter Setup

5.1. Differences between Display Units

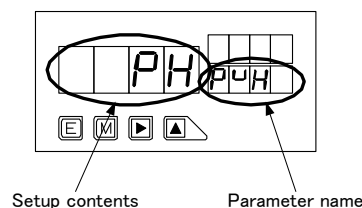

5.1.1. Multi-display Unit

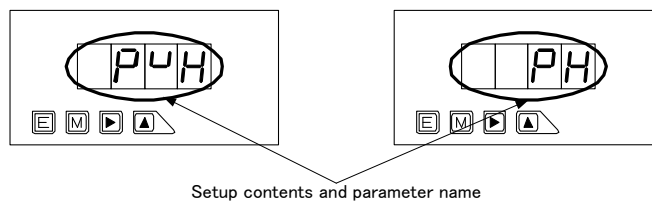

Note: Pressing the Mode key displays the next parameter.

5.1.2. Single Display Unit

Note 1: Pressing the mode key with the parameter name shown changes the display to the parameter information indication. If there is no key operation for about one second when the parameter name is shown, the display automatically changes to the parameter information indication (however, this change does not automatically occur for parameters PH/S-HI/FSC, etc., right after COND/COM/MET is indicated).

Note 2: Pressing the Mode key when the parameter information indication is shown results in the next parameter being displayed.

Note 3: If there is no key operation for about 8 seconds with the parameter information indication shown, the display returns to the parameter name indication.

5.4. Information on Each Parameter

Indication	Name	Setup options	Default value
Condition data			
PVH	Peak hold setup	PH (peak hold)/VH (valley hold)/PVH (peak-valley hold)	PH
RANG	Measurement range setup	*1	*1
AVG	Number of averaging operations setup	1/2/4/8/10/20/40/80	1
MAV	Number of moving average operations setup	OFF/2/4/8/16/32	OFF
S.UD	Step width setup	1(1digit)/2(2digit)/5(5digit)/0(10digit)	1
BLNK	Indication blank setup	OFF/B-3/B-2/B-1/ON	OFF
UNIT	Unit setup	C/F	C
BAUD	Baud rate setup	9600/4800/2400/384(38400)/192(19200)	9600
DATA	Data length setup	7(7bit)/8(8bit)	7bit
P.BIT	Parity bit setup	E (even number), O (odd number), N (none)	E
S.BIT	Stop bit setup	2(2bit)/1(1bit)	2
T-	Delimiter setup	CR, LF, (CR+LF)/CR	CRLF
ADR	Equipment ID setup	01 to 99	00
A.OUT	Analog output setup	OFF/0-1(0 to 1V)/0-10(0 to 10V)/1-5(1 to 5V)/4-20(4 to 20mA)	OFF
B.UP	Digital zero backup setup	OFF/ON	OFF
LINE	Linearization setup	OFF/ON	CLR
I.SEL	Input selection	OC (open collector)/LGC (logic)/MAG (magnet)	O.C
TR T	Tracking zeroing time setup	00 to 99	00
TR V	Tracking zeroing width setup *2	00 to 99	01
SNSR	Sensor power setup	10(10V)/5(5V)	5
PON	Power on delay time setup	OFF/ON	OFF
PRO	Protect setup	OFF/1 to 30	OFF
U-NO	Unit number indication setup	OFF/ON	ON
Comparator data			
S-HI	HI side judgment value setup	-9999 to 9999	1000
S-LO	LO side judgment value setup	-9999 to 9999	500
H-HI	HI side hysteresis setup	0 to 999	0
H-LO	LO side hysteresis setup	0 to 999	0
Scaling data			
FSC	Full scale indication value setup	-9999 to 9999	
FIN	Full scale input value setup	*In the case of AC input, please use it by "+" setting by all means. It is not displayed normally when I use it by "-" setting.	*1
OFS	Offset indication value setup		
OIN	Offset input value setup		
PS	Pre-scaling value setup	0.001 to 5.000	1.000
PPR	Frequency division setup	1 to 100	1
DLHI	Digital limiter HI value setup	-9999 to 9999	9999
DLLO	Digital limiter LO value setup	-9999 to 9999	-9999
AOHI	Analog output HI indication setup	-9999 to 9999	9999
AOLO	Analog output LO indication setup	-9999 to 9999	0
DEP	Decimal point indication position setup	None/place of 10 ⁰ /place of 10 ¹ /place of 10 ² /place of 10 ³	None
Linearization data			
		*2	*2
Calibration data			
ZERO	Zero input value	-0.300 to 2.000	0.000
SPIN	Span input value	1.000 to 3.000	2.000
SPAN	Span indication	0 to 9999	9000

5.4.1 Method of Setting Condition Data

This section shows a typical example of setting the peak hold parameter. The same method applies to other parameters.

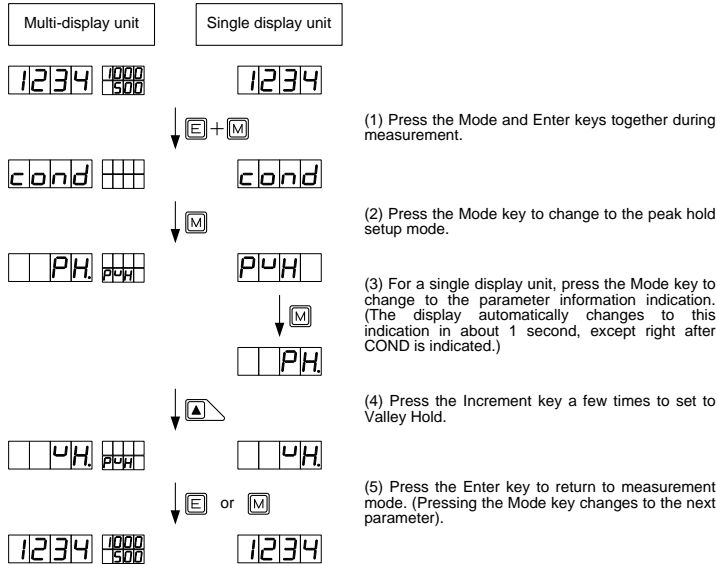

5.4.2 Method of Setting Comparator Data

This section explains comparator data and shows a typical example of setting the HI side judgment value. The same method applies to all other parameters.

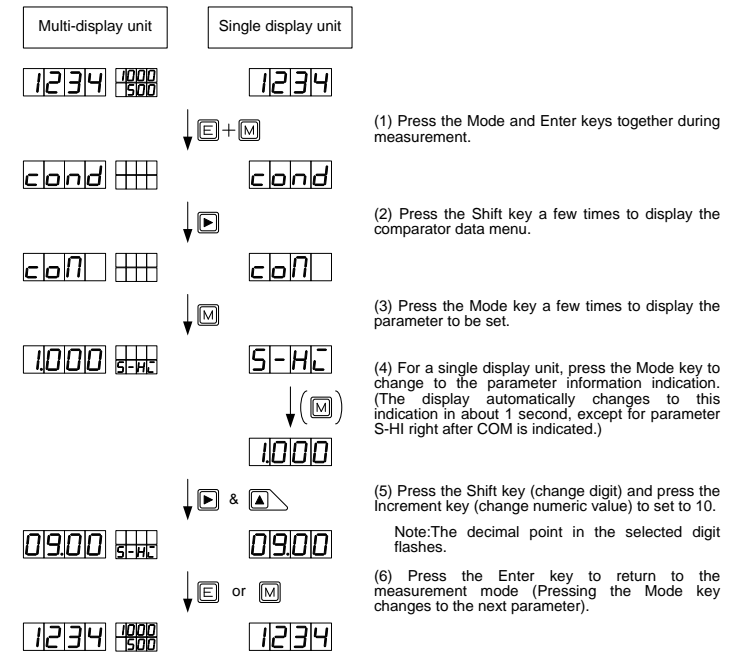
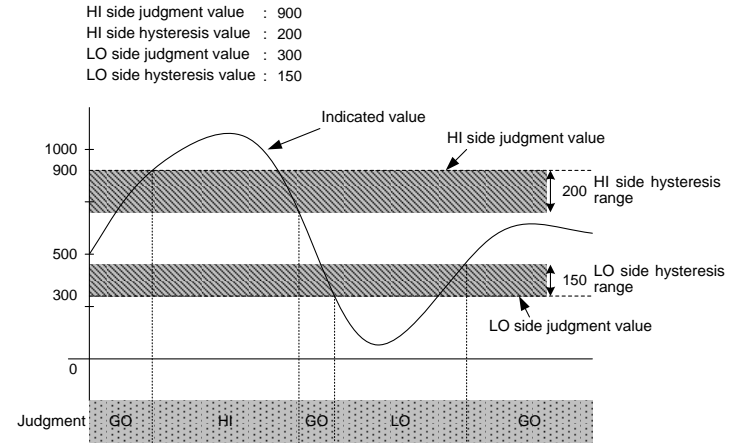

Note: The setup conditions are HI side judgment value > LO side judgment value, HI side judgment value ³ LO side judgment value + LO side hysteresis, and LO side judgment value £ HI side judgment value - HI side hysteresis. If these conditions are not satisfied, an error indication appears and the display returns to the HI side judgment value setup.

5.4.3 Method of Setting Scaling Data

This section explains comparator data and shows a typical example of setting the full scale indication parameter. The same method applies to all other parameters.

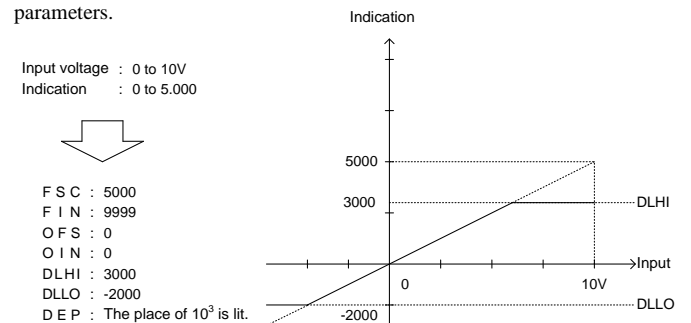

Note: For the Digital limiter, values larger than the DLHI setpoint are not indicated even if signals greater than the value set in the DLHI parameter are input (for DLLO parameter, values smaller than the DLLO setpoint are not indicated).

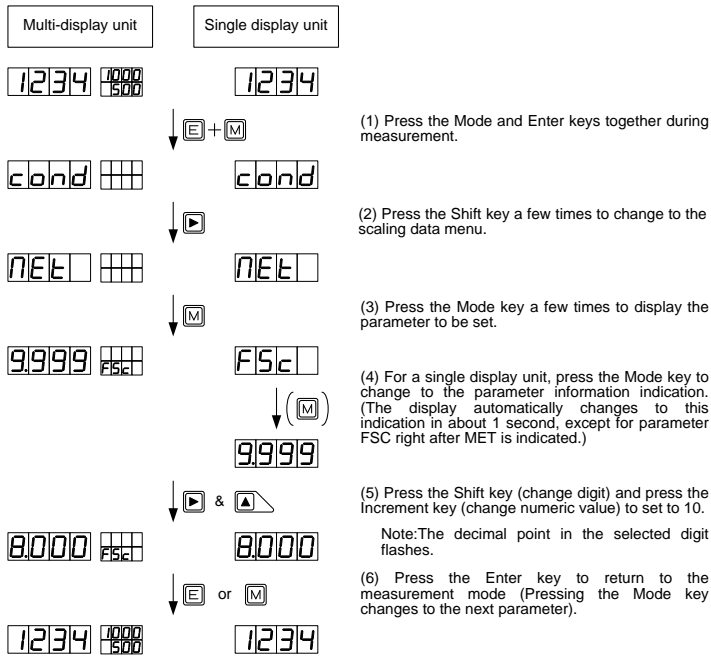

Note: For the process signal measuring unit, set the full scale input value to 5.000 for the 1 V range and to 20.00 for the 2 A range, and set the offset input value to 1.000 for the 1 V range and to 4.00 for the 2 A range. The following explains the frequency measuring unit. (The same method applies to the full scale indication parameter.)

Determining the revolution speed (rpm) using the rotary encoder set to 30 pulses per minute:

- Determine the measurement range by calculating the maximum frequency. The figure below shows an example where the revolution rises to a maximum speed of about 100 rpm.

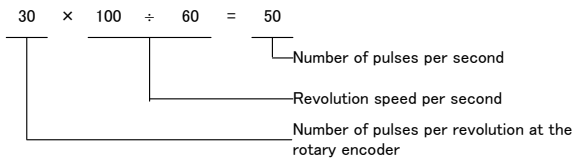

- Since the number of pulses determined in (1) is 50 per second (50 Hz), set the range to range 11 (for how to set the range, see the section on setting condition data).
- The display unit shows 500 if 50 Hz pulse input is measured under range 11 (when PS=1 and PPR=1 by default). Therefore, the parameters should be set as PS=2 and PPR=1 so that the decimal point is positioned in the 10¹ digit (100.0 is indicated 50 Hz input).

Note: For the frequency measuring unit, set the relationship between the input and indication using the PS and PPR parameters (parameters of FSC, FIN, OFS, and OIN are not indicated).

The following explains the scaling of analog output (The same method applies to the full scale indication parameter.)

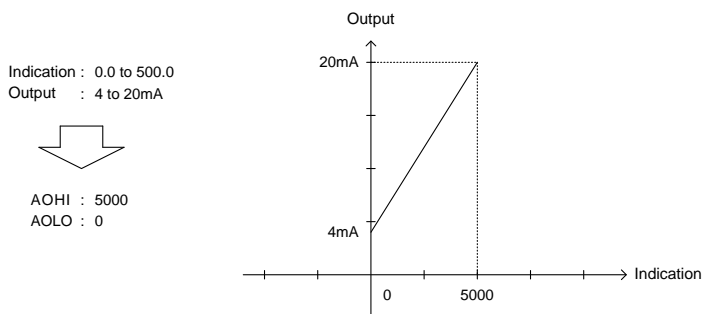

- Note1: For analog output scaling, set the indication value for an output current of 20 mA in the AOHI parameter and set the indication value for an output current of 4 mA in the AOLO parameter (for 4-20 mA output).
- Note2: The analog signal out of the setting range cannot be accurately output.

5.4.4 Method of Setting Calibration Data

5.4.4.1 Actual Load Calibration

Actual load calibration means that calibration is carried out by applying actually measured pressure to a sensor such as a load cell connected to the meter.

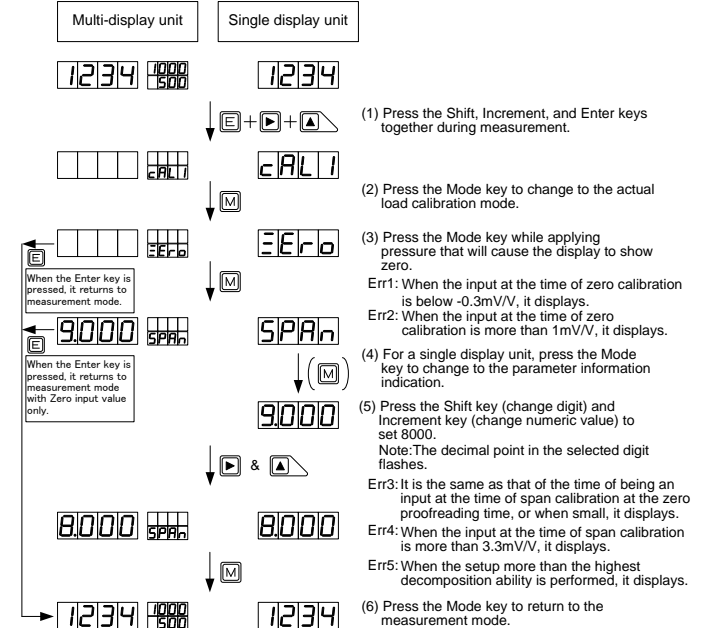

5.4.4.2 Equivalent Calibration

Equivalent calibration means that calibration is carried out according to the ratings (specifications) of such a sensor as a load cell. It is not necessary to connect the sensor or to apply pressure to the sensor.

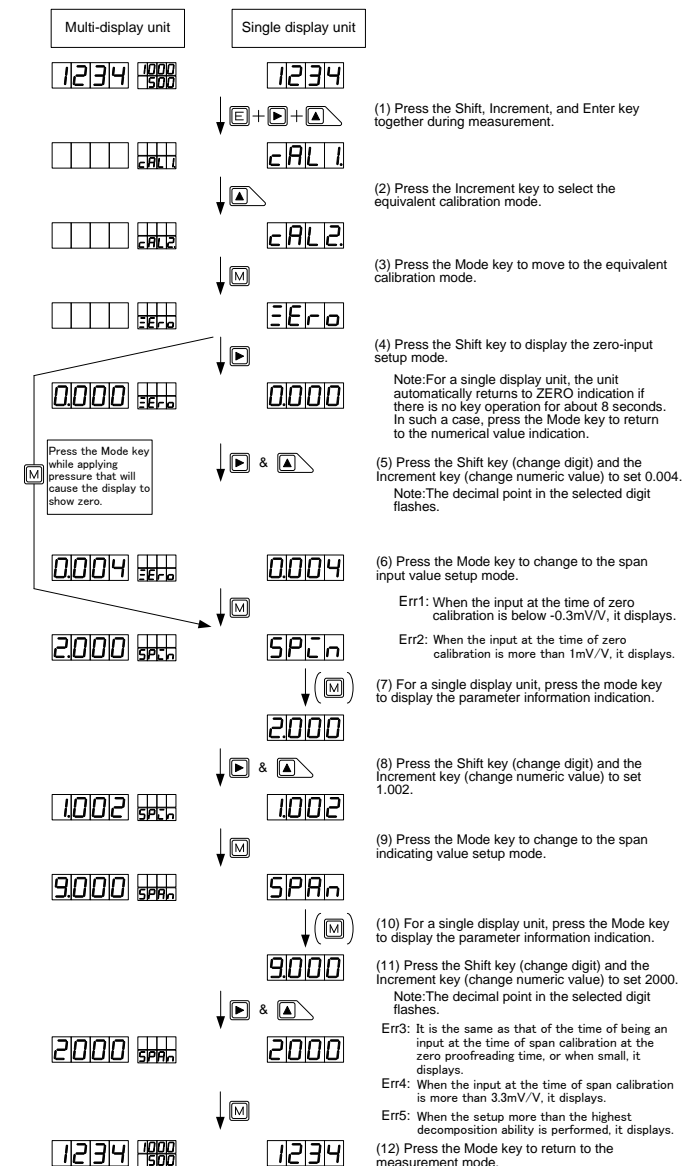

5.4.5 Method of Setting Linearization Data

The linearization function means a function that changes the slope of straight lines in the relationship between the input and indication by correcting the relations at arbitrary points. Linearization data are set using the input value (indicated value before correction) and the output value (indicated value after correction) at each arbitrary point.

(1) Press the Mode key and the Enter key during measurement.

(2) Press the Shift key a few times to move to the linearization data menu.

(3) Press the Mode key to move to the setup for the number of data to be corrected.

(4) Press the Shift key (change digit) and the Increment key (change numeric value) and then press the Mode Key to after the number of data to be corrected has been set.

Note: The decimal point in the selected digit flashes.

(5) For a single display unit, press the Mode key to change to the parameter information indication.

Note: For a single display unit, the unit automatically returns to N-01 indication if there is no key operation for about 8 seconds. In this case, press the Mode key to return to the numeric value indication.

(6) Press the Shift key (change digit) and Increment key (change numeric value) and then press the Mode key after the N-01 input value has been set.

Note: For a single display unit, RE flashes when the input value is set and DZ flashes when the output value is set.

(7) Press the Shift key (change digit) and Increment key (change numeric value) and then press the Mode key after the N-01 output value has been set.

(8) Press the Mode key to display the setup for output values of the data to be corrected.

Note: For a single display unit, the unit is automatically returned to N-02 indication if there is no key operation for about 8 seconds. In this case, press the Mode key to return to the numeric value indication.

(9) Press the Shift key (change digit) and Increment key (change numeric value) and then press the Mode key after the N-02 input value has been set.

Repeat steps (5) to (9) until all the settings have been made.

(10) When all the settings have been made, press the Enter key to return to the measurement mode.

Note: The setup conditions are N-1 < N-2 ... N-15 < N-16.

6. Control Functions

6.1 Hold Function

The Hold function temporarily retains the indication. The hold function is enabled by shortcircuiting the HOLD and COM terminals or setting both terminals to the same voltage level. As a result the display unit retains the indication given at that moment.

6.2 Digital Zero Function

The Digital Zero function zeros the indication given at an arbitrary timing. Thereafter, the function shows the amount of change from the point of zeroing. However, this function serves as an indication resetting function for a frequency measuring unit. Thus, the Digital Zero function can be used to reset the indication when there is no input signal at all.

Note that, the on/off control of the Digital Zero function can be achieved by means of terminal control or front panel keys. In the case of terminal control, the Digital Zero function is turned on by shortcircuiting the DZ and COM terminals or setting both terminals to the same voltage level. The indication at that moment is zeroed. In the case of control with the front panel keys, hold down the Mode key and press the Increment key for about 1 second to zero the indication at that moment.

Note: Operation with the control terminals takes priority over operation with the front panel keys. The Digital Zero function is disabled if the control terminals are made to go through the off-on-off sequence with the function enabled by means of the front panel keys.

6.3 Peak Hold Function

The Peak Hold function retains one of the maximum (peak hold)/minimum (valley hold)/maximum - minimum (peak-valley hold) values and provides output for that value. Selection from these values is made using the condition data. The peak hold function is enabled by shortcircuiting the PH and COM terminals or setting both terminals to the same voltage level.

7. Output Function

7.1 Comparison Output Function

The A5000 series of unit meters is designed so that the two judgment values HI and LO can be set for the measured (indicated) value to provide the results of judgment as relay contact output. (This function is effective when the meter is equipped with a comparison output unit.) For details on the contact ratings and other specifications, refer to the section "Output Specifications."

7.2 Analog Output Function

The A5000 series of unit meters can output an analog signal for an indicated value (when the meter is equipped with an analog output unit). There are four output ranges, 0 to 1 V/0 to 10 V/1 to 5 V/4 to 20 mA, from which a selection can be made using the condition data. In addition, the analog output of the A5000 series allows for arbitrary output scaling. This scaling can be achieved by setting the indication value for an output of the maximum scale value (20 mA for 4-20 mA output range) in the AOHI parameter of the scaling data.

7.3 RS-485 Interface Function

The A5000 series can be equipped with an RS-485 interface (when the meter is provided with an RS-485 unit). For details on the RS-485 function, see the separate manual on communication functions.

7.4 RS-232C Interface Function

The A5000 series can be equipped with an RS-232C interface (when the meter is provided with an RS-232C unit). For details on the RS-232C function, see the separate manual on communication functions.

8. Specifications and External Dimensions

8.1 Input Specifications

8.1.1 DC Voltage Measuring Unit (range 11)

Range	Measurement range	Indication	Highest resolution	Input impedance	Maximum permissible input	Accuracy
11	±99.99mV	Offset : ±9999 Full scale : 0 to ±9999	10 μV	About 100MΩ	±100V	±(0.1% of FS)

Input circuit : Single ended type
 Operating system : ΔΣ conversion
 Maximum sampling rate : 12.5 times per second
 Noise rejection ratio : NMR (normal mode rejection) 50 dB or more (50 or 60 Hz)

8.1.2 DC Voltage Measuring Unit (ranges 12 to 15)

Range	Measurement range	Indication	Highest resolution	Input impedance	Maximum permissible input	Accuracy
12	±999.9mV	Offset : ±9999 Full scale : 0 to ±9999	100 μV	About 100MΩ	±100V	±(0.1% of FS)
13	±9.999V		1mV	About 1MΩ	±250V	
14	±99.99V		10mV	About 10MΩ	±250V	±(0.15% of FS)
15	±600V		100mV	About 10MΩ	±600V	

Input circuit : Single ended type
 Operating system : ΔΣ conversion
 Maximum sampling rate : 12.5 times per second
 Noise rejection ratio : NMR (normal mode rejection) 50 dB or more (50 or 60 Hz)

8.1.3 DC Current Measuring Unit

Range	Measurement range	Indication	Highest resolution	Input impedance	Maximum permissible input	Accuracy
23	±9.999mA	Offset : ±9999 Full scale : 0 to ±9999	1 μA	About 10Ω	±100mA	±(0.2% of FS)
24	±99.99mA		10 μA	About 1Ω	±500mA	
25	±999.9mA		100 μA	About 0.1Ω	±3A	±(0.3% of FS)

Input circuit : Single ended type
 Operating system : ΔΣ conversion
 Maximum sampling rate : 12.5 times per second
 Noise rejection ratio : NMR (normal mode rejection) 50 dB or more (50 or 60 Hz)

8.1.4 AC Voltage Measuring Unit (average value detection: ranges 11 to 13)

Range	Measurement range	Indication	Highest resolution	Input impedance	Maximum permissible input	Accuracy
11	99.99mV	Offset : ±9999 Full scale : 0 to ±9999	10 μV	1MΩ or more	±100V ±250V	±(0.2% of FS +10digit)
12	999.9mV		100 μV			
13	9.999V		1mV			

Input circuit : Single ended type
 Operating system : ΔΣ conversion
 Maximum sampling rate : 12.5 times per second
 Frequency range : 40 Hz to 1 kHz
 Response speed : About 1 second
 Dead zone : 0 to 99 digits

8.1.5 AC Voltage Measuring Unit (average value detection: ranges 14 and 15)

Range	Measurement range	Indication	Highest resolution	Input impedance	Maximum permissible input	Accuracy
14	99.99V	Offset : ±9999 Full scale : 0 to ±9999	10mV	1MΩ or more	250V	±(0.2% of FS +10digit)
15	600V		100mV		600V	

Input circuit : Single ended type
 Operating system : ΔΣ conversion
 Maximum sampling rate : 12.5 times per second
 Frequency range : 40 Hz to 1 kHz
 Response speed : About 1 second
 Dead zone : 0 to 99 digits

8.1.6 AC Voltage Measuring Unit (true rms value: ranges 11 to 13)

Range	Measurement range	Indication	Highest resolution	Input impedance	Maximum permissible input	Accuracy
11	99.99mV	Offset : ±9999 Full scale : 0 to ±9999	10 μV	1MΩ or more	±100V ±250V	±(0.2% of FS +20digit)
12	999.9mV		100 μV			
13	9.999V		1mV			

Input circuit : Single ended type
 Operating system : ΔΣ conversion
 Maximum sampling rate : 12.5 times per second
 Frequency range : 40 Hz to 1 kHz
 Response speed : About 1 second
 Crest factor : 4:1 at full scale
 Dead zone : 0 to 99 digits
 *The accuracy applied to a sine wave that equals or exceeds 5% of the measurement range.
 *"0" may not be displayed infrequently under the influence of the DC cut condenser of the input part when turning on the power with no signal, but it is not trouble.
 It normally operates if the signal in measurement range is given.

8.1.7 AC Voltage Measuring Unit (true rms value: ranges 14 and 15)

Range	Measurement range	Indication	Highest resolution	Input impedance	Maximum permissible input	Accuracy
14	99.99V	Offset : ±9999 Full scale : 0 to ±9999	10mV	1MΩ or more	250V	±(0.2% of FS +20digit)
15	600V		100mV		600V	

Input circuit : Single ended type
 Operating system : ΔΣ conversion
 Maximum sampling rate : 12.5 times per second
 Frequency range : 40 Hz to 1 kHz
 Response speed : About 1 second
 Crest factor : 4:1 at full scale
 Dead zone : 0 to 99 digits
 *The accuracy applied to a sine wave that equals or exceeds 5% of the measurement range.
 *"0" may not be displayed infrequently under the influence of the DC cut condenser of the input part when turning on the power with no signal, but it is not trouble.
 It normally operates if the signal in measurement range is given.

8.1.8 AC Current Measuring Unit (average value detection: ranges 23 to 25)

Range	Measurement range	Indication	Highest resolution	Input impedance	Maximum permissible input	Accuracy
23	9.999mA	Offset : ±9999 Full scale : 0 to ±9999	1 μA	About 10Ω	100mA	±(0.5% of FS +10digit)
24	99.99mA		10 μA	About 1Ω	500mA	
25	999.9mA		100 μA	About 0.1Ω	3A	

Input circuit : Single ended type
 Operating system : ΔΣ conversion
 Maximum sampling rate : 12.5 times per second
 Frequency range : 40 Hz to 1 kHz
 Response speed : About 1 second
 Crest factor : 4:1 at full scale
 Dead zone : 0 to 99 digits

8.1.9 AC Current Measuring Unit (average value detection: range 26)

Range	Measurement range	Indication	Highest resolution	Input impedance	Maximum permissible input	Accuracy
26	5A	Offset : ±9999 Full scale : 0 to ±9999	1mA	(CT)	8A	±(0.5% of FS +10digit)

Input circuit : CT isoration type
 Operating system : ΔΣ conversion
 Maximum sampling rate : 12.5 times per second
 Frequency range : 50 Hz or 60Hz
 Response speed : About 1 second
 Crest factor : 4:1 at full scale
 Dead zone : 0 to 99 digits

8.1.10 AC Current Measuring Unit (true rms value: ranges 23 to 25)

Range	Measurement range	Indication	Highest resolution	Input impedance	Maximum permissible input	Accuracy
23	9.999mA	Offset : ±9999 Full scale : 0 to ±9999	1 μA	About 10Ω	100mA	±(0.5% of FS +20digit)
24	99.99mA		10 μA	About 1Ω	500mA	
25	999.9mA		100 μA	About 0.1Ω	3A	

Input circuit : Single ended type
 Operating system : ΔΣ conversion
 Maximum sampling rate : 12.5 times per second
 Frequency range : 40 Hz to 1 kHz
 Response speed : About 1 second
 Crest factor : 4:1 at full scale
 Dead zone : 0 to 99 digits
 *The accuracy applied to a sine wave that equals or exceeds 5% of the measurement range.
 *"0" may not be displayed infrequently under the influence of the DC cut condenser of the input part when turning on the power with no signal, but it is not trouble.
 It normally operates if the signal in measurement range is given.

8.1.11 AC Current Measuring Unit (true rms value: range 26)

Range	Measurement range	Indication	Highest resolution	Input impedance	Maximum permissible input	Accuracy
26	5A	Offset : ±9999 Full scale : 0 to ±9999	1mA	(CT)	8A	±(0.5% of FS +20digit)

Input circuit : CT isoration type
 Operating system : ΔΣ conversion
 Maximum sampling rate : 12.5 times per second
 Frequency range : 50 Hz or 60Hz
 Response speed : About 1 second
 Crest factor : 4:1 at full scale
 Dead zone : 0 to 99 digits
 *The accuracy applied to a sine wave that equals or exceeds 5% of the measurement range.
 *"0" may not be displayed infrequently under the influence of the DC cut condenser of the input part when turning on the power with no signal, but it is not trouble.
 It normally operates if the signal in measurement range is given.

8.1.12 Resistance Measuring Unit

Range	Measurement range	Indication	Highest resolution	Circuit current	Accuracy
11	99.99Ω	Offset : ±9999 Full scale : 0 to ±9999	10mΩ	About 5mA	±(0.2% of FS)
12	999.9Ω		100mΩ	About 500 μA	
13	9.999kΩ		1Ω	About 50 μA	
14	99.99kΩ		10Ω	About 5 μA	

Input circuit : Single ended type
 Operating system : ΔΣ conversion
 Maximum sampling rate : 12.5 times per second
 Measuring system : Two-wire system or four-wire system (internal socket change-over)
 Open-circuit voltage : About 5 V

8.1.13 Temperature Measuring Unit (TC)

Range	Input sensor	Indication	Highest resolution	Accuracy
KA	K	-50.0 to 199.9°C (-58.0 to 391.8° F)	0.1°C (0.1° F)	±(0.5% of FS)
KB	K	-50 to 1200°C (-58 to 2192° F)	1°C (1° F)	±(0.2% of FS)
J	J	-50 to 1000°C (-58 to 1832° F)		
T	T	-50 to 400°C (-58 to 752° F)		
S	S	0 to 1700°C (32 to 3092° F)		
R	R	-10 to 1700°C (14 to 3092° F)		
B	B	100 to 1800°C (212 to 3272° F)	±(0.4% of FS) Note : The accuracy of range B is applicable to temperatures of 500°C or more.	

Input circuit : Single ended type
 Operating system : ΔΣ conversion
 Maximum sampling rate : 6.25 times per second
 Cold junction compensation error : ±2°C (at 10 through 40°C)
 Internal resistance of sensor : 50Ω or less
 Linearizer : Digital linearizer
 Burnout alarm : It blinks by — display.

8.1.14 Temperature Measuring Unit (RTD)

Range	Input sensor	Indication	Highest resolution	Accuracy
PA	PT100Ω	-100.0 to 199.9°C (-148.0 to 391.8° F)	0.1°C (0.1° F)	±(0.15% of FS)
JPA	JPt100Ω			
PB	PT100Ω	-100 to 600°C (-148 to 1112° F)	1°C (1° F)	±(0.3% of FS)
JPB	JPt100Ω			

Input circuit : Single ended type
 Operating system : $\Delta \Sigma$ conversion
 Maximum sampling rate : 12.5 times per second
 Current through RTD : About 1 mA
 External resistance : 10Ω or less per wire
 Linearizer : Digital linearizer
 Burnout alarm : It blinks by ---- display.

8.1.15 Frequency Measuring Unit (open collector, logic, and magnet)

Range	Measurement range	Indication	Highest resolution	Renewal time of a display	Accuracy
11	0.1 to 200Hz	Pre-scale : 0.001 to 5 Frequency division : 1 to 100	0.1Hz	10s	±(0.2% of FS)
12	1 to 2000Hz		1Hz	1s	
13	0.01 to 20kHz		10Hz	100ms	
14	0.1 to 200kHz		100Hz	100ms	

Input type	Input voltage level	Maximum permissible input
Open collector	LO : 1V or less (5V : 4.7kΩ pull up)	15V
Logic	LO : 1V or less, HI : 2.5 to 15V	
Magnet	0.3 to 30Vp-p	

Duty ratio : 50%

8.1.16 Frequency Measuring Unit (500 Vrms)

Range	Measurement range	Indication	Highest resolution	Renewal time of a display	Accuracy
11	0.1 to 200Hz	Pre-scale : 0.001 to 5 Frequency division : 1 to 100	0.1Hz	10s	±(0.2% of FS)
12	1 to 2000Hz		1Hz	1s	
13	0.01 to 20kHz		10Hz	100ms	
14	0.1 to 200kHz		100Hz	10ms	

Input type	Input voltage level	Maximum permissible input
Voltage	50 to 500Vrms	500Vrms

Duty ratio : 50%

8.1.17 Strain Gage Unit

Sensor power	Zero adjusting range	Span adjusting range	Measurement range	Highest resolution	Accuracy
5V	-0.3 to +1mV/V	1 to 3mV/V	0 to 3mV/V	0.5μV/digit	±(0.1% of FS +2digit)
10V				1μV/digit	

Input circuit : Single ended type
 Operating system : $\Delta \Sigma$ conversion
 Maximum sampling rate : 12.5 times per second
 Noise rejection ratio : NMR (normal mode rejection) 50 dB or more (50 or 60 Hz)

8.1.18 Process Signal Measuring Unit

Range	Measurement range	Indication	Input impedance	Maximum permissible input	Accuracy
1V	1 to 5V	Offset : ±9999 Full scale : 0 to ±9999	About 100MΩ	±100V	±(0.2% of FS)
2A	4 to 20mA		About 10Ω	±100mA	

Input circuit : Single ended type
 Operating system : $\Delta \Sigma$ conversion
 Maximum sampling rate : 12.5 times per second
 Noise rejection ratio : NMR (normal mode rejection) 50 dB or more (50 or 60 Hz)

8.2 Common Specifications

Display : 7-segment LED display (character height : 14.2 mm on main display and 8 mm on sub-display)
 Polarity indication : Automatically indicated when the calculated result is negative.
 Indication range : -9999 to 9999
 Over-range alarm : OL or -OL for input signals outside the indication range
 Decimal point : Can be set at an arbitrary digit.
 Zero indication : Leading zero suppression
 External control : HOLD, PH, DZ (reset for frequency measuring unit)
 Operating temperature and humidity range : 0 to 50°C , 35 to 83%RH(non-condensing)

Storage temperature and humidity range : -10 to 70°C , 60%RH or less
 Power supply : 100 to 240V AC ±10% for AC power supply unit
 9 to 60 V DC for DC power supply unit
 Power consumption : 7VA max. (AC power supply)
 7W max. (DC power supply)
 External dimensions : 96 mm (W) × 48 mm (H) × 146.5 mm (D)
 Note : Depth (D) denotes the maximum value.
 Weight : 450g
 Withstand voltage : 2000V AC for 1 min. between power terminals and input terminal, and between power terminals and each output terminal (AC power supply)
 Withstand voltage : 500V DC for 1 min. between power terminals and input terminal, and between power terminals and each output terminal (DC power supply)
 Withstand voltage : 500V DC for 1 min. between input terminal and each output terminal, and between analog output terminal and communication terminals
 2000 V AC for 1min between ccase and each output terminal (common to both AC and DC supply)
 Insulation resistance : 100 MΩ between the above terminals when 500 V DC is applied
 Conformity standard : EN61326-1 EMI : Class A EMS : Industrial locations EN61010-1 (Transducer is applied to standard by the input and output signal line length less than 30m.) EN50581
 It applies only to the product with which CE mark is indicated on the label.
 Grounding environment : Category II , Pollution degree 2
 Altitude : 2000m max
 Fuse : K19372 1.0A (DC power supply)

8.3 Output Specifications

8.3.1 Output for Comparison

Conditions for comparison	Judgment result
Indicated value > Upper limit judgment value	HI
Lower limit judgment value ≤ Indicated value ≤ Upper limit judgment value	GO
Lower limit judgment value > Indicated value	LO

Control system : Micro computer operating system
 Judgment value setup range : -9999 to +9999
 Hysteresis : Can be set in the range of 1 to 999 digits for each judgment value
 Operating speed : Depends on the sampling rate.
 Output method : Relay contact output (Make and break contacts for HI and LO and make contacts for GO)
 Output rating : 240 V AC, 8 A (resistive load) and 30 V DC, 8 A (resistive load)
 Mechanical life : 20,000,000 times or more
 Electric life : 100,000 times or more (Resistance load)

8.3.2 Analog Output

Output type	Load resistance	Accuracy	Ripple
0 to 1V	10kΩ or more	±(0.5% of FS)	±50mVp-p
0 to 10V	10kΩ or more		
1 to 5V	10kΩ or more		±25mVp-p
4 to 20mA	550Ω or less		

Note: The ripple ratings for the 4–20 mA output are when the load resistance of 250Ω and the output current of 20 mA are applied.

Conversion system : PWM conversion

Resolution : Equivalent to 13 bits

Scaling : Digital scaling

Response speed : About 0.5 second

8.3.3 Communicating Function

	RS-232C	RS-485
Synchronization system	Start and stop synchronization	
Communication system	Full duplex	Two wire half duplex (Polling selecting system)
Communication rate	38400bps/ 19200bps/ 9600bps/ 4800bps/ 2400bps	
Start bit	1bit	
Data length	7bit/8bit	
Error detection	Even parity/ odd parity/ non-parity	
	BCC (block, check, and character check sum)	
Stop bit	1bit/2bit	
Character code	ASCII code	
Communication control procedure	No procedure	
Signal name used	TXD RXD SG	Non-inversion(+) and inversion(-)
Number of connectable units	1	1 Up to 31 meters
Line length	15m	Up to 500m (total) In EN/IEC conformity, it is under 30m.
Delimiter	CR+LF/CR	

8.4 External Dimensions

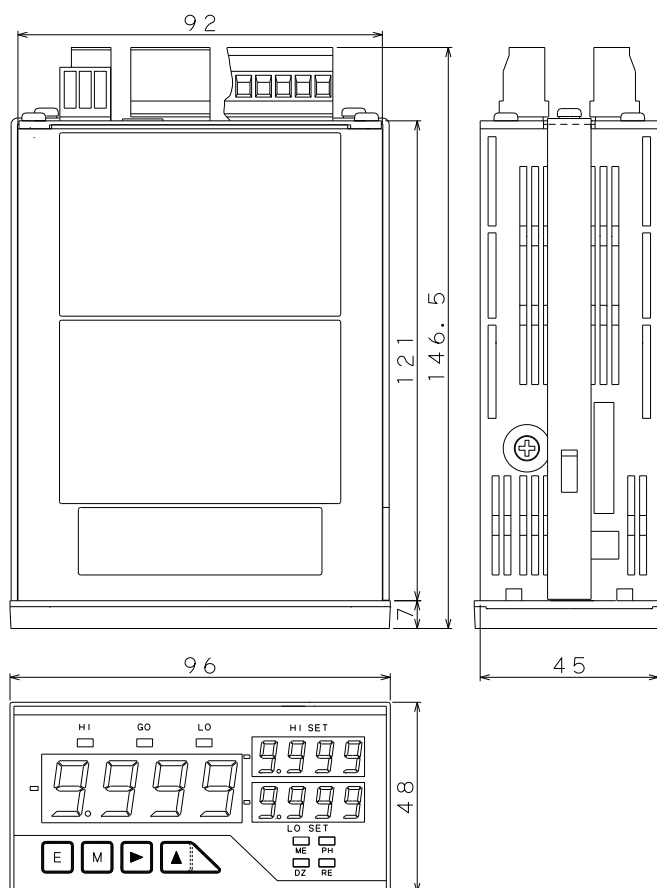

9. Warranty and After-service

9.1 Warranty

The warranty period shall be one year from the date of delivery. Any failure that arises during this period and the cause thereof is judged to be obviously attributable to Watanabe Electric Industry Co., Ltd. shall be remedied at no cost.

9.2 After-service

This product is manufactured, tested, inspected, and then shipped under stringent quality control. Should the product fail, however, contact (or send the product to) your vendor or Watanabe Electric Industry directly. (It is advisable that you send a memo describing the failure in as much detail as possible along with the product returned.)

Setting table

Indication	Name	Default value	
Condition data			
PVH	Peak hold setup	PH	
RANG	Measurement range setup	*1	
AVG	Number of averaging	1	
MAV	Number of moving averaging setup	OFF	
S.U.D	Step wide setup	1	
BLNK	Indication blank setup	OFF	
UNIT	Unit setup	C	
BAUD	Baud rate setup	9600	
DATA	Data length setup	7	
P.BIT	Parity bit setup	E	
S.BIT	Stop bit setup	2	
T-	Delimiter setup	CR.LF	
ADR	Equipment ID setup	00	
A.QUIT	Analog output setup	OFF	
B.UP	Digital zero backup setup	OFF	
LINE	Linearization setup	CLR	
I.SEL	Input selection	OC	
TR T	Tracking zeroing time setup	00	
TR V	Tracking zeroing width setup *2	01	
SNSR	Sensor power setup	5	
PON	Power-on delay setup	OFF	
PRO	Protect setup	OFF	
U-NO.	Unit number Indication setup	ON	
Comparator data			
S-HI	HI side judgment value setup	1000	
S-LO	LO side judgment value setup	500	
H-HI	HI side hysteresis setup	0	
H-LO	LO side hysteresis setup	0	

Indication	Name	Default value	
Scaling data			
FSC	Full scale Indication value setup	*1	
FIN	Full scale input value setup	*1	
OFS	Offset indication value setup	*1	
OIN	Offset input value setup	*1	
PS	Pre-scaling value setup	1	
PPR	Frequency division setup	1	
DLHI	Digital limiter HI value setup	9999	
DLLO	Digital limiter LO value setup	-9999	
AOHI	Analog output HI indication setup	9999	
AOLO	Analog output LO indication setup	0	
DEP	Decimal point position setup	None	
Linearization data		*5	
Calibration data			
ZERO	Zero input value *6	0	
SPIN	Span input value *6	2000	
SPAN	Span indication	9000	
Shift data			
SHF	Shift data setup	0	

- *1 Each value in the lower part of a cell in the columns on the right is the default value.
 - *2 Tracking zero width setup parameter is not indicated if the tracking time is set to OFF(0).
 - *5 Linearization data are not set up for the default values.
 - *6 This value is not indicated if calibration is done using an actual load.
- The shaded parts show the parameters that must be set for each unit.
- *When the power turns on while pressing all the keys (Enter, Mode, Shift and Increment).
and held pressed until LEDs are all lit, then all data initializes to the default settings.

 WATANABE ELECTRIC INDUSTRY CO., LTD.	6-16-19, Jingumae, Shibuya-ku, Tokyo 150-0001, Japan Phone: (81)3-3400-6141 Homepage http://www.watanabe-electric.co.jp/en/
--	--

A5000 Series

Communication Functions User's Manual

1. Overview

This manual explains the specifications of the communication functions provided by the A5000 series of digital panelmeters. It also explains how to handle the A5000 series.

2. Specifications

	RS-232C (Compatible with EIA RS-232C)	RS-485 (Compatible with EIA RS-485)
Synchronization	Start-stop	
Communication method	Full-duplex	Two-wire half-duplex (polling/selecting)
Transmission rate	2400, 4800, 9600, 19200, 38400 bps	
Number of start bits	1bit	
Data length	7 bits / 8 bits	
Error detection	Even parity, odd parity, or no parity	
		Block check character (BCC) checksum
Number of stop bits	1 bits / 2 bits	
Character code	ASCII	
Transmission control procedure	Non-procedural	
Signal name used	TXD, RXD, SG	Non-inverting (+), inverting (-)
Number of units that can be connected	1	31 for meters
Transmission line length	15 m	500 m max. (overall length)
Delimiter	CR+LF/CR	

3. Terminal Assignments and Connection Method

The communication connector of the A5000 series is a modular jack RJ-14(6P4C) compatible with the FCC68 standard. Use a modular plug RJ-14(6P4C) also compatible with the FCC68 standard when connecting the panelmeter.

3.1. Terminal Assignments

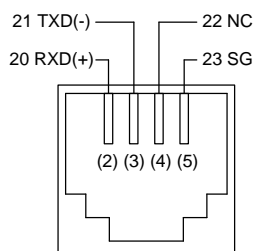

RS-232C/RS-485 connector

Terminal No.	Name	Description
20	RXD(+)	RS-232C: Receive Data terminal; RS-485: Non-inverting output
21	TXD(-)	RS-232C: Transmit Data terminal; RS-485: Inverting output
22	NC	Do not connect.
23	SG	Common terminal for the communication functions

3.2. Example of RS-232C Connection

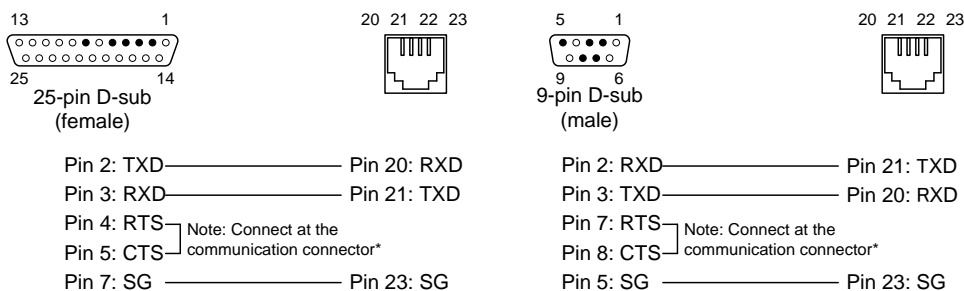

Note: The above-illustrated connection of the CTS and RTS terminals on the host side is only a typical example for hardware control. Consult your system designer for further details on how to cope with the terminals.

3.3. Example of RS-485 Connection

If the panelmeter is positioned to be an end station as the result of an RS-485 connection, set the terminator to ON by using the selector socket in the A5000 output unit.

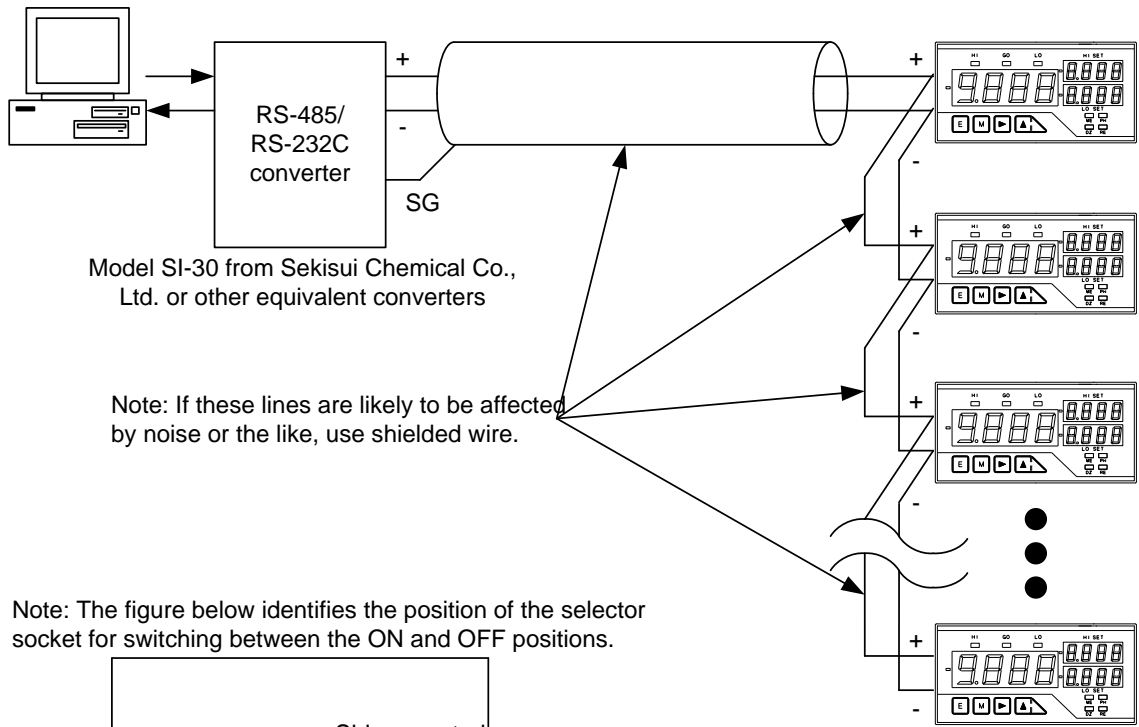

Note: The figure below identifies the position of the selector socket for switching between the ON and OFF positions.

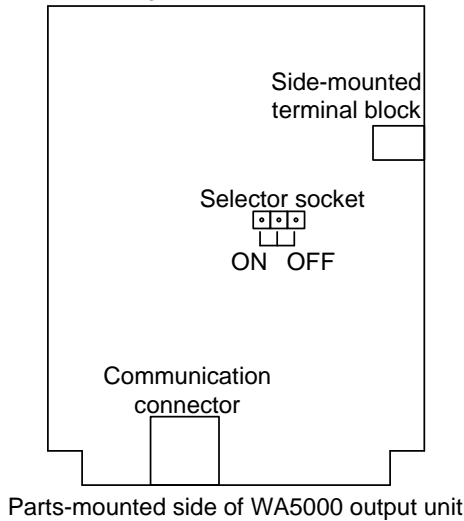

Note: If the panelmeter is an end station, set the terminator to ON.

4. Communication Function Parameters

The baud rate, data length, parity bit, stop bit, delimiter, and device ID (RS-485 only) are the user-selectable parameters of the communication functions provided by the A5000 panelmeter. For details on how to set the parameters, see the user's manual of the A5000 main unit.

5. RS-485 Transmission/Reception Formats

5.1. Establishing and Releasing the Communication Link

Function	1	2	3	4	5	6	7	8	9	10	11	12	13	14	15	16	17	18	19	20	21	22	23	Char. Length	1	2	3	4	5	6	7	8	9	10	11	12	13	14	15	16	17	18	19	20	Char. Length		
Establishment of communication link	ENQ	0	1	CR	LF																			3	ACK	0	1	CR	LF															3			
	Note: Set a two-digit number as the device ID (00 is void).																								Note: The response time is 40 ms maximum.																						
Release of communication link	EO	CR	LF																					1																							
	Note: Communication is still possible when another device ID is specified without releasing the communication link.																								Note: (No response is made if the device ID is wrong.)																						
																									Note: (No response is made for release.)																						
																									Note: The response time is 20 ms maximum.																						

5.2. Available Control Codes

Control Code	Hexadecimal	Name	Description
STX	02H	Start of Text	Marks the starting point of text.
ETX	03H	End of Text	Marks the ending point of text.
EOT	04H	End of Transmission	Marks the end of transmission.
ENQ	05H	Enquiry	Denotes an enquiry.
ACK	06H	Acknowledge	Denotes an affirmative reply.

Function	1 2 3 4 5 6 7 8 9 10 11 12 13 14 15 16 17 18 19 20 21 22 23	Char. Length	1 2 3 4 5 6 7 8 9 10 11 12 13 14 15 16 17 18 19 20	Char. Length
Digital zero backup status response	B : D : Z : CR : LF :	3	B : D : Z : O : N : CR : LF : (Response with the status of digital zero backup being ON.) B : D : Z : O : F : F : CR : LF : (Response with the status of digital zero backup being OFF.)	6 7
Digital zero backup control	B : D : Z : O : N : CR : LF : (Sets digital zero backup to ON.) B : D : Z : O : F : F : CR : LF : (Sets digital zero backup to OFF.)	6 7	Y : E : S : CR : LF : Y : E : S : CR : LF :	5 5
Digital zero data save command	S : A : V : CR : LF :	3	Y : E : S : CR : LF : N : O : ? : CR : LF : (Response with the status of digital zero backup being OFF.)	5 5
Input selection response	I : S : E : L : CR : LF :	4	O : . : C : CR : LF : (Response with the status of the input selection option being "open collector.") L : O : G : CR : LF : (Response with the status of the input selection option being "logic.") M : A : G : CR : LF : (Response with the status of the input selection option being "magnet.") N : O : ? : CR : LF : (Response with the status of the frequency measurement unit not being installed.)	3 3 3 5
Input selection setting	I : S : E : L : O : C : CR : LF : (Sets the input selection option to "open collector.") I : S : E : L : L : O : G : CR : LF : (Sets the input selection option to "logic.") I : S : E : L : M : A : G : CR : LF : (Sets the input selection option to "magnet.")	8 8 8	Y : E : S : CR : LF : Y : E : S : CR : LF : Y : E : S : CR : LF : N : O : ? : CR : LF : (Response with the status of the frequency measurement unit not being installed.)	5 5 5 5
Tracking zero response	T : R : K : CR : LF :	3	O : N : T : = : 1 : W : = : 1 : CR : LF : (Response with the status of the tracking zero time being 1 and tracking zero width being 1.) O : N : T : = : 9 : 9 : W : = : 9 : 9 : CR : LF : (Response with the status of the tracking zero time being 99 and tracking zero width being 99.) T : R : K : O : F : F : CR : LF : (Response with the status of the tracking zero function being set to OFF.)	10 12 7
Tracking zero setting	T : R : K : T : = : 1 : CR : LF : (Sets the tracking zero time to 1.) T : R : K : T : = : 9 : 9 : CR : LF : (Sets the tracking zero time to 99.) T : R : K : W : = : 1 : CR : LF : (Sets the tracking zero width to 1 digit.) T : R : K : W : = : 9 : 9 : CR : LF : (Sets the tracking zero width to 99 digits.) T : R : K : T : = : 0 : CR : LF : (Sets the tracking zero function to OFF.)	7 8 7 8 7	Y : E : S : CR : LF : Y : E : S : CR : LF : Y : E : S : CR : LF : Y : E : S : CR : LF : Y : E : S : CR : LF :	5 5 5 5 5
Sensor power supply response	S : N : S : R : CR : LF :	4	S : N : S : R : 1 : 0 : CR : LF : (Response with the status of sensor power supply being set to 10 V.) S : N : S : R : 5 : CR : LF : (Response with the status of sensor power supply being set to 5 V.)	7 6
Sensor power supply setting	S : N : S : R : 1 : 0 : CR : LF : (Sets the sensor power supply to 10 V.) S : N : S : R : 5 : CR : LF : (Sets the sensor power supply to 5 V.)	7 6	Y : E : S : CR : LF : Y : E : S : CR : LF :	5 5
Power-on delay time response	P : O : N : CR : LF :	3	P : O : N : O : F : F : CR : LF : (Response with the status of the power-on delay function being set to OFF.) P : O : N : 1 : CR : LF : (Response with the status of the power-on delay function being set to 1 sec.) P : O : N : 3 : 0 : CR : LF : (Response with the status of the power-on delay function being set to 30 sec.)	7 5 6
Power-on delay time setting	P : O : N : CR : LF : (Sets the power-on delay function to 1 sec.) P : O : N : 3 : 0 : CR : LF : (Sets the power-on delay function to 30 sec.) P : O : N : 0 : CR : LF : (Sets the power-on delay function to OFF.)	5 6 5	Y : E : S : CR : LF : Y : E : S : CR : LF : Y : E : S : CR : LF :	5 5 5
Protection response	P : R : O : CR : LF :	3	P : R : O : O : F : F : CR : LF : (Response with the status of the protection function being set to OFF.) P : R : O : O : N : CR : LF : (Response with the status of the protection function being set to ON.)	7 6
Protection setting	P : R : O : O : F : F : CR : LF : (Sets the protection function to OFF.) P : R : O : O : N : CR : LF : (Sets the protection function to ON.)	7 6	Y : E : S : CR : LF : Y : E : S : CR : LF :	5 5
Unit number response	U : N : O : CR : LF :	3	1 : - : 1 : 7 : . : O : - : 6 : CR : LF : (Response with the status of the input unit being strain gauge measurement and the output unit being a combination of comparison output, analog output and RS-232C.) 1 : - : 0 : 1 : . : O : - : 3 : CR : LF : (Response with the status of the input unit being DC voltage measurement (11 ranges) and the output unit being RS-232C.)	8 8
Key operation prohibition response	K : E : Y : CR : LF :	3	K : E : Y : O : F : F : CR : LF : (Response with the status of the key operation prohibition function being set to OFF.) K : E : Y : O : N : CR : LF : (Response with the status of the key operation prohibition function being set to ON.)	7 6
Key operation prohibition setting	K : E : Y : O : F : F : CR : LF : (Sets the key operation prohibition function to OFF.) K : E : Y : O : N : CR : LF : (Sets the key operation prohibition function to ON.)	7 6	Y : E : S : CR : LF : Y : E : S : CR : LF :	5 5
Comparator data response	C : O : M : CR : LF : Note: The reading of the main unit changes to COM the moment it receives a COM command.	3	S : - : H : I : 1 : 0 : 0 : 0 : CR : LF : (Response with the HI-side judgment value.) S : - : L : O : 5 : 0 : 0 : 0 : CR : LF : (Response with the LO-side judgment value.) H : - : H : I : 0 : CR : LF : (Response with the HI-side hysteresis.) H : - : L : O : 0 : CR : LF : (Response with the LO-side hysteresis.) Y : E : S : CR : LF :	10 10 10 10 5
Comparator data setting	C : O : M : CR : LF : Note: The reading of the main unit changes to COM the moment it receives a COM command. 8 : 0 : 0 : 0 : CR : LF : (Sets the HI-side judgment value to 8000.) N : CR : LF : 4 : 0 : 0 : 0 : CR : LF : (Sets the LO-side judgment value to 4000.) R : CR : LF : Note: If an R command is sent after setting required data, the main unit saves data provided up to that moment and then returns to measurement operation.	3 4 1 4 1	S : - : H : I : 1 : 0 : 0 : 0 : CR : LF : S : - : H : I : 8 : 0 : 0 : 0 : CR : LF : S : - : L : O : 5 : 0 : 0 : 0 : CR : LF : S : - : L : O : 4 : 0 : 0 : 0 : CR : LF : Y : E : S : CR : LF : E : r r o r : CR : LF : (Response when a value that does not meet the setting conditions is input.)	10 10 10 10 5 6

Function	1	2	3	4	5	6	7	8	9	10	11	12	13	14	15	16	17	18	19	20	Char. Length																																		
Scaling data response	M E T	C R	L F																		3	F S C	9	9	9	9	C R	L F	10																										
	Note: The reading of the main unit changes to MET the moment it receives an MET command.																																																						
	N	C R	L F																			1	F I N	9	9	9	9	C R	L F	10																									
	Note: The reading of the main unit changes to MET the moment it receives an MET command.																																																						
	N	C R	L F																			1	O F S	0				C R	L F	10																									
	Note: The reading of the main unit changes to MET the moment it receives an MET command.																																																						
	N	C R	L F																			1	O I N	0				C R	L F	10																									
	Note: The reading of the main unit changes to MET the moment it receives an MET command.																																																						
	N	C R	L F																			1	D L H I	9	9	9	9	C R	L F	10																									
	Note: The reading of the main unit changes to MET the moment it receives an MET command.																																																						
	N	C R	L F																			1	D L L O	9	9	9	9	C R	L F	10																									
	Note: The reading of the main unit changes to MET the moment it receives an MET command.																																																						
	N	C R	L F																			1	A O H I	9	9	9	9	C R	L F	10																									
	Note: The reading of the main unit changes to MET the moment it receives an MET command.																																																						
N	C R	L F																			1	A O L O	0				C R	L F	10																										
Note: The reading of the main unit changes to MET the moment it receives an MET command.																																																							
N	C R	L F																			1	D E P	4				C R	L F	6																										
Note: The reading of the main unit changes to MET the moment it receives an MET command.																																																							
R	C R	L F																			1	Y E S					C R	L F	5																										
Note: The main unit returns to measurement operation upon an R command (or returns to the response with the full-scale reading if an N command is sent.)																																																							
Scaling data setting	M E T	C R	L F																		3	F S C	9	9	9	9	C R	L F	10																										
	Note: This example shows a case where FSC is set to 8000 and OFS to 20.																																																						
	8	0	0	0	C R	L F															4	F S C	8	0	0	0	C R	L F	10																										
	(Sets the full-scale reading to 8000.)																																																						
	N	C R	L F																			1	F I N	9	9	9	9	C R	L F	10																									
Note: If an R command is sent after setting required data, the main unit saves data provided up to that moment and then returns to measurement operation.																																																							
N	C R	L F																			1	O F S	0				C R	L F	10																										
(Sets the offset reading to 20.)																																																							
2	0	C R	L F																		2	O F S	2	0			C R	L F	10																										
(Sets the offset reading to 20.)																																																							
R	C R	L F																			1	Y E S					C R	L F	5																										
Note: If an R command is sent after setting required data, the main unit saves data provided up to that moment and then returns to measurement operation.																																																							
E r r o r																																									6	C R	L F												
Note: (Response when a value outside the setpoint range is input.)																																																							
Linearization function status response	L I N	O F F	C R	L F																	3	L I N	O F F	C R	L F																														
	Note: (Response with the status of the linearization function being set to OFF.)																																																						
	L I N	O N	C R	L F																		6	L I N	O N	C R	L F																													
	Note: (Response with the status of the linearization function being set to ON.)																																																						
	L I N	C L R	C R	L F																		7	L I N	C L R	C R	L F																													
Note: (Response with the status of the linearization function being cleared.)																																																							
Linearization function status setting	L I N	O F F	C R	L F																	7	Y E S					C R	L F	5																										
	Note: (Sets the linearization function to an OFF status.)																																																						
	L I N	O N	C R	L F																	6	Y E S					C R	L F	5																										
	Note: (Sets the linearization function to an ON status.)																																																						
	L I N	C L R	C R	L F																		7	Y E S					C R	L F	5																									
Note: (Sets the linearization function to a cleared status.)																																																							
N O ?																																									5	C R	L F												
Note: (Response with the status of the linearization function being cleared.)																																																							
Note: Since the linearization data are all cleared when the linearization function is cleared, the main unit does not accept either a LIN ON or LIN OFF command. (Set the linearization function status after setting the linearization data again.)																																																							
Response for number of linearization correction data items	L N O	0	0	C R	L F																3	L N O	0	0	0	C R	L F	6																											
	Note: (Response with the status of the linearization function being cleared.)																																																						
	L N O	0	2	C R	L F																	6	L N O	0	2	C R	L F	6																											
	Note: (Response with the status of the number of linearization correction data items being 02.)																																																						
Setting for number of linearization correction data items	L N O	0	2	C R	L F																	6	Y E S				C R	L F	5																										
	Note: (Sets the number of linearization correction data items to 02.)																																																						
	L N O	1	6	C R	L F																	6	Y E S				C R	L F	5																										
	Note: (Sets the number of linearization correction data items to 16.)																																																						
E r r o r																																									6	C R	L F												
Note: (Response when linearization data is not correctly set.)																																																							
Note: Set the number of linearization correction data items after setting linearization data.)																																																							
Linearization data response	L N D	0	1	C R	L F																6	L N D	0	1	I =	0	C R	L F	14																										
	Note: A reading can be made from any of the data items 01 to 16.																																																						
	Note: The reading of the main unit changes to LINE the moment it receives an LND XX command.																																																						
	N	C R	L F																			1	L N D	0	1	O =																													

Function	1	2	3	4	5	6	7	8	9	10	11	12	13	14	15	16	17	18	19	20	Char. Length	
Calibration data response	CAL2	CR	LF																		4	
	Note: The reading of the main unit changes to CAL2 the moment it receives a CAL2 command.																					
	J	CR	LF																			1
	(Response with a zero input value.)																					
	N	CR	LF																			1
	(Response with a span input value.)																					
	R	CR	LF																			1
	(Response with a span reading.)																					
	Note: The main unit returns to measurement operation upon an R command (or returns to the zero point input value response if an N command is sent.)																					
	Calibration data setting (Calibration with actual load)	CAL1	CR	LF																		4
Note: The main unit moves to the setting of a span reading if a J command is sent.																						
N		CR	LF																			1
(Executes zero calibration.)																						
5000		CR	LF																			4
(Sets the span reading to 5000.)																						
N		CR	LF																			1
(Executes span calibration.)																						
R		CR	LF																			1
Note: If an R command is sent during setting, the main unit saves data provided up to that moment and then returns to measurement operation (span reading is not saved, however.)																						
Calibration data setting (Equivalent calibration)	CAL2	CR	LF																		4	
	0004	CR	LF																		4	
	(Sets the zero input value to 0.004 mV/V.)																					
	N	CR	LF																			1
	(Executes zero calibration.)																					
	1502	CR	LF																			4
	(Sets the span input value to 1.502 mV/V.)																					
	N	CR	LF																			1
	(Executes span calibration.)																					
	5000	CR	LF																			4
(Sets the span reading to 5000.)																						
N	CR	LF																			1	
(Executes span calibration.)																						
Common response	YES	CR	LF																		5	
	(Normal response)																					
	NO?	CR	LF																			5
	(Response to, e.g., undefined commands.)																					
	ERROR	CR	LF																			6
	(Response to out-of-range data or data that do not meet setting conditions.)																					
	ERROR	CR	LF																			7
	(Response when there is any communication parameter failure.)																					
	Note: Under normal conditions, this response is made only once.																					
	Note: ERROR B to ERROR F are available as the response commands for acknowledgment.																					
Note: If a response to the ERROR X command is received, execute the same processing once again. If the panelmeter still does not recover, turn off the panelmeter once and then turn it on again.																						
DATA	CR	LF																			14	
(Response in case of condition data failure.)																						
Note: Set the condition data again.																						
DATA	CR	LF																			13	
(Response in case of comparator data failure.)																						
Note: Set the comparator data again.																						
DATA	CR	LF																			13	
(Response in case of scaling data failure.)																						
Note: Set the scaling data again.																						
Response in case of data failure in the internal memory	Note: Under normal conditions, this response is made only once.																					